

# Linking KNX installations with other protocols and systems

NETxAutomation

WOLFGANG GRANZER & BASTIAN ELSNER | 15.11.23

elsner | academy

**NETx**  
AUTOMATION

# Agenda

1. Speakers
2. Introduction: Elsner Elektronik GmbH
3. Introduction: NETxAutomation Software GmbH
4. KNX Integration
5. Products



# Your Speakers



**Bastian Elsner**  
CEO  
Elsner Elektronik



**Stefan Baumgartner**  
Sales Manager  
NETxAutomation



**Wolfgang Granzer**  
Product Manager  
NETxAutomation

# 1 | Introduction: Elsner Elektronik

# What is the advantage of working together?

- Competitive purchase of NETx is possible via Elsner
- Technical regional support from NETx and consultation
- Elsner specialisation paired with NETx solution to fulfill project requirements
- Project one stop solution with hardware (Modbus, KNX, BACnet) and NETx Visualization to full BMS platform with seamless integration
- GRMS, BMS, Visualization and multi protocol approach
- Scalable seamless integration with secure remote access and control tailored for your building automation project powered by NETx and Elsner

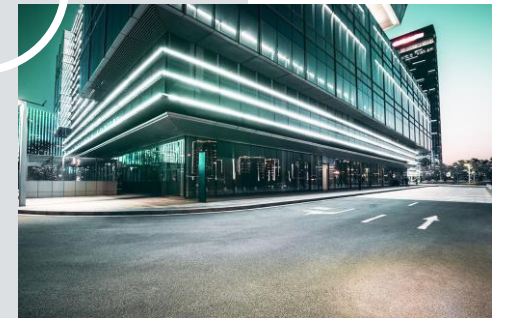



A photograph of a modern, multi-story glass building facade, likely a corporate headquarters, with a dark blue tint. The building features a grid of windows and a prominent corner structure. The foreground shows a paved street with white directional arrows.

# 1 | Introduction: NETxAutomation Software GmbH

# NETxAutomation Software GmbH



# NETx solutions – main goals

Applications are based on open,  
world-wide standards

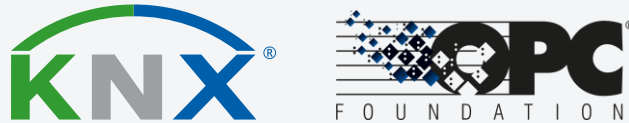

## Continuous development and enhancement of products



Member of OPC Foundation,  
KNX Association, BACnet International, Modbus  
Organization



Participation in the development  
of standard specifications



Close cooperation with universities:  
TU Vienna, University Antwerp, University Dresden  
for knowledge transfer



EU-wide research projects allow the integration of  
new systems and technologies



# Solution overview

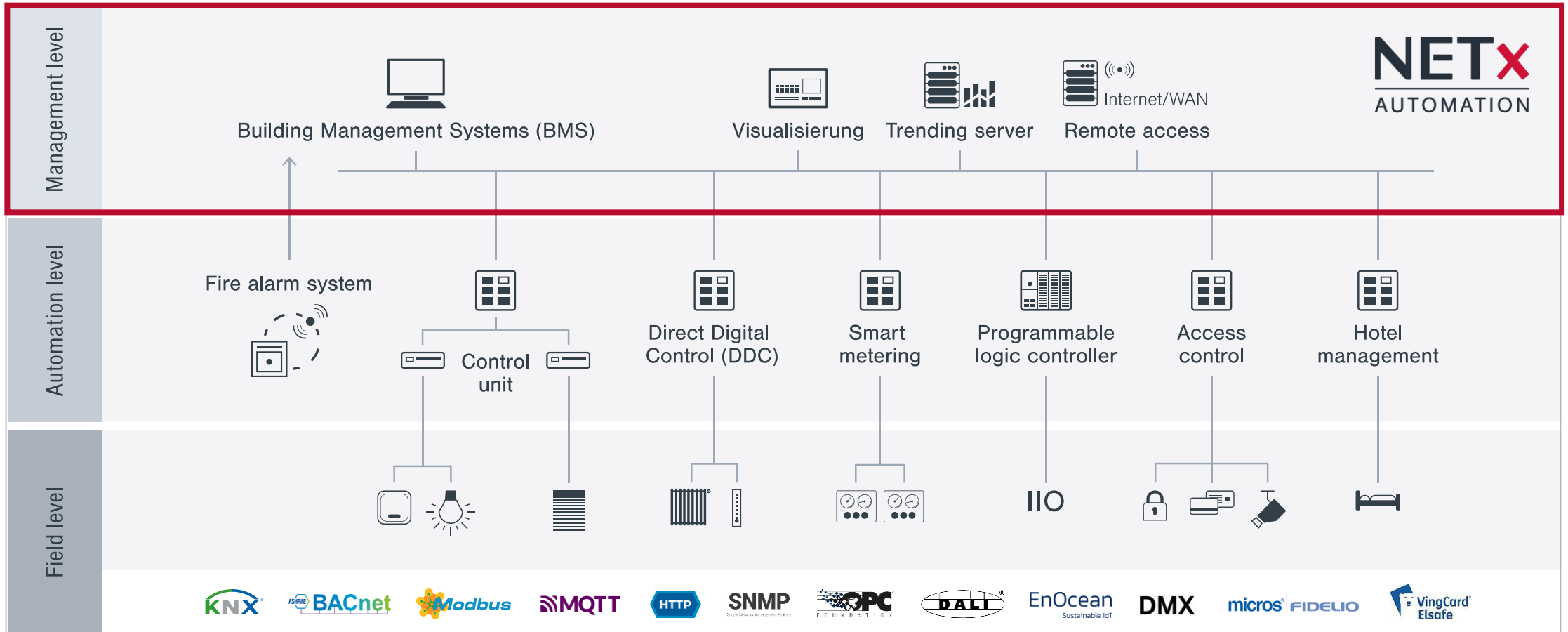

## 2 | Products

# NETx BMS Platform

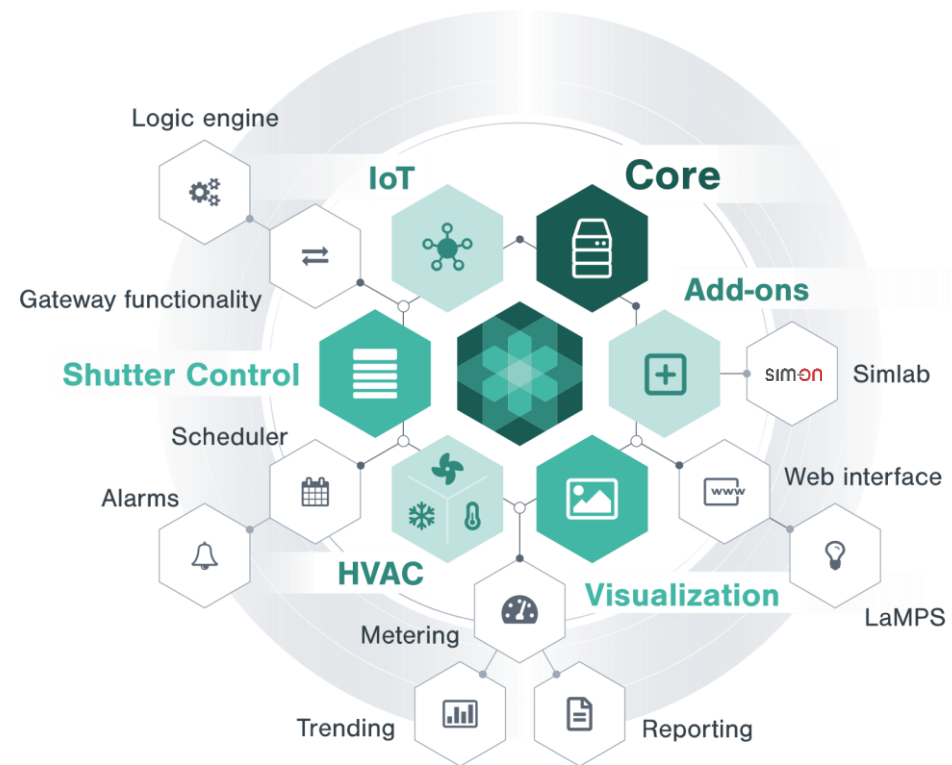



# NETx BMS Platform

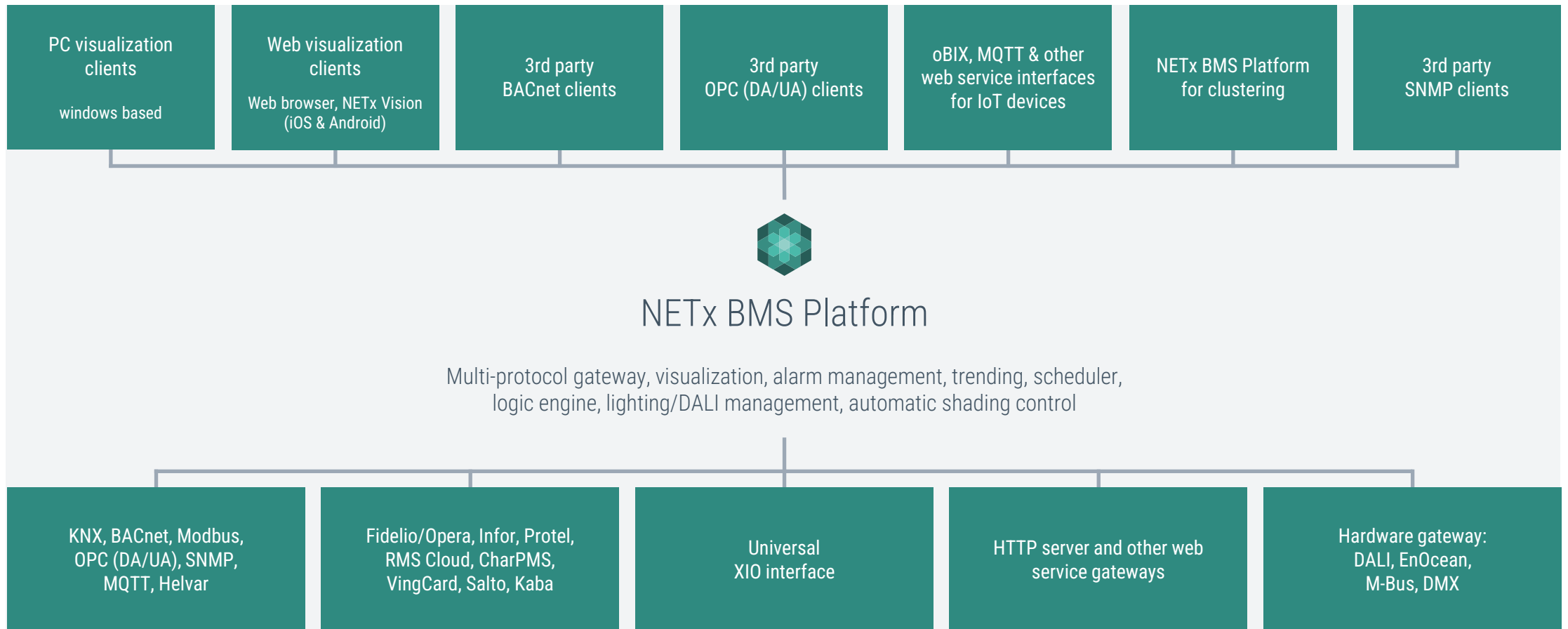

# NETx Multi Protocol Server

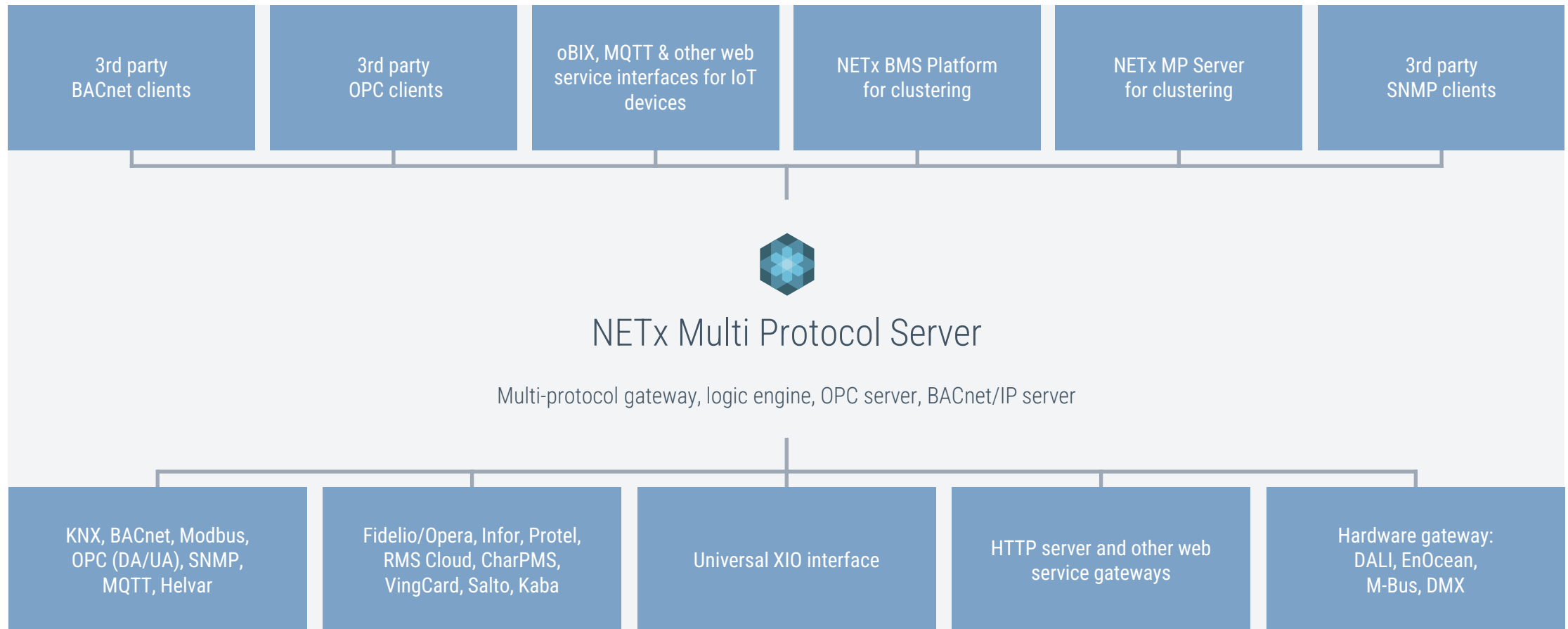

## 3 | KNX Integration



# TP Classical configuration (TP Coupling)

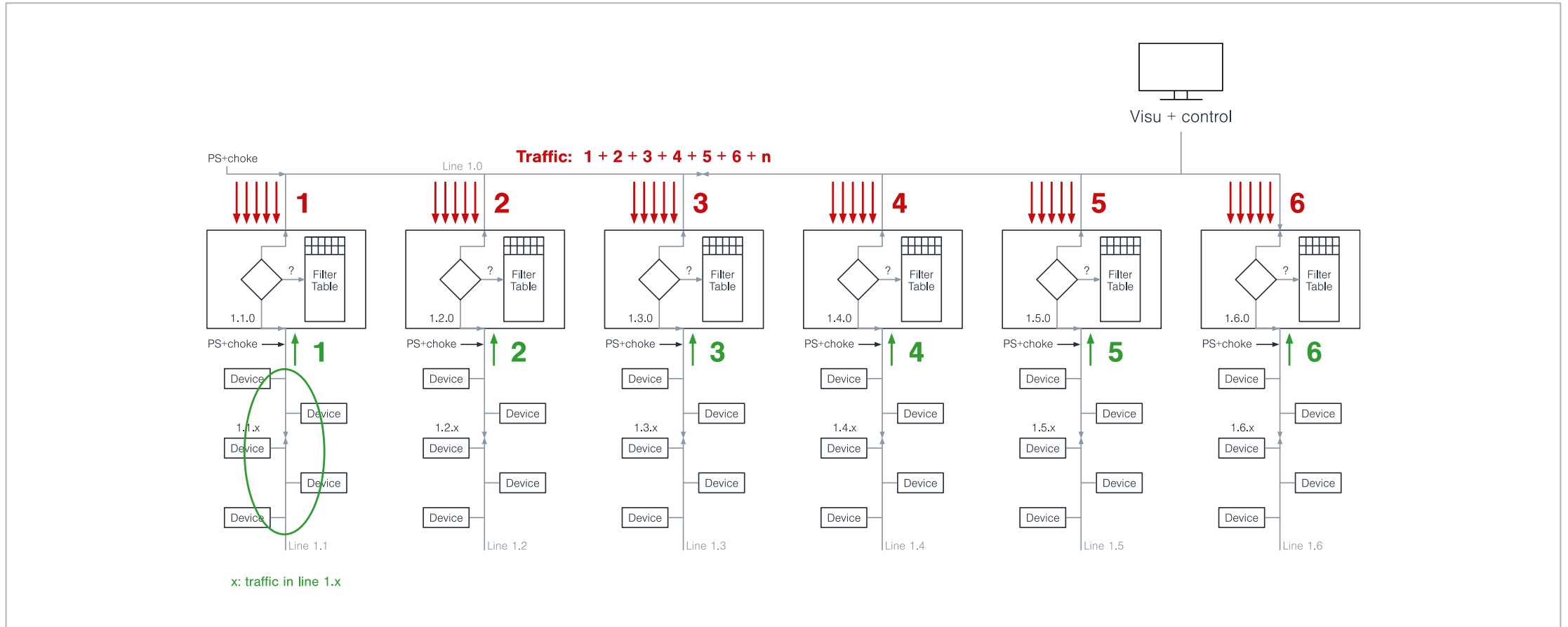

# IP configuration including NETx Platform (IP routers)

- No bandwidth issue
- No coupler bottleneck
- No need to edit filter tables

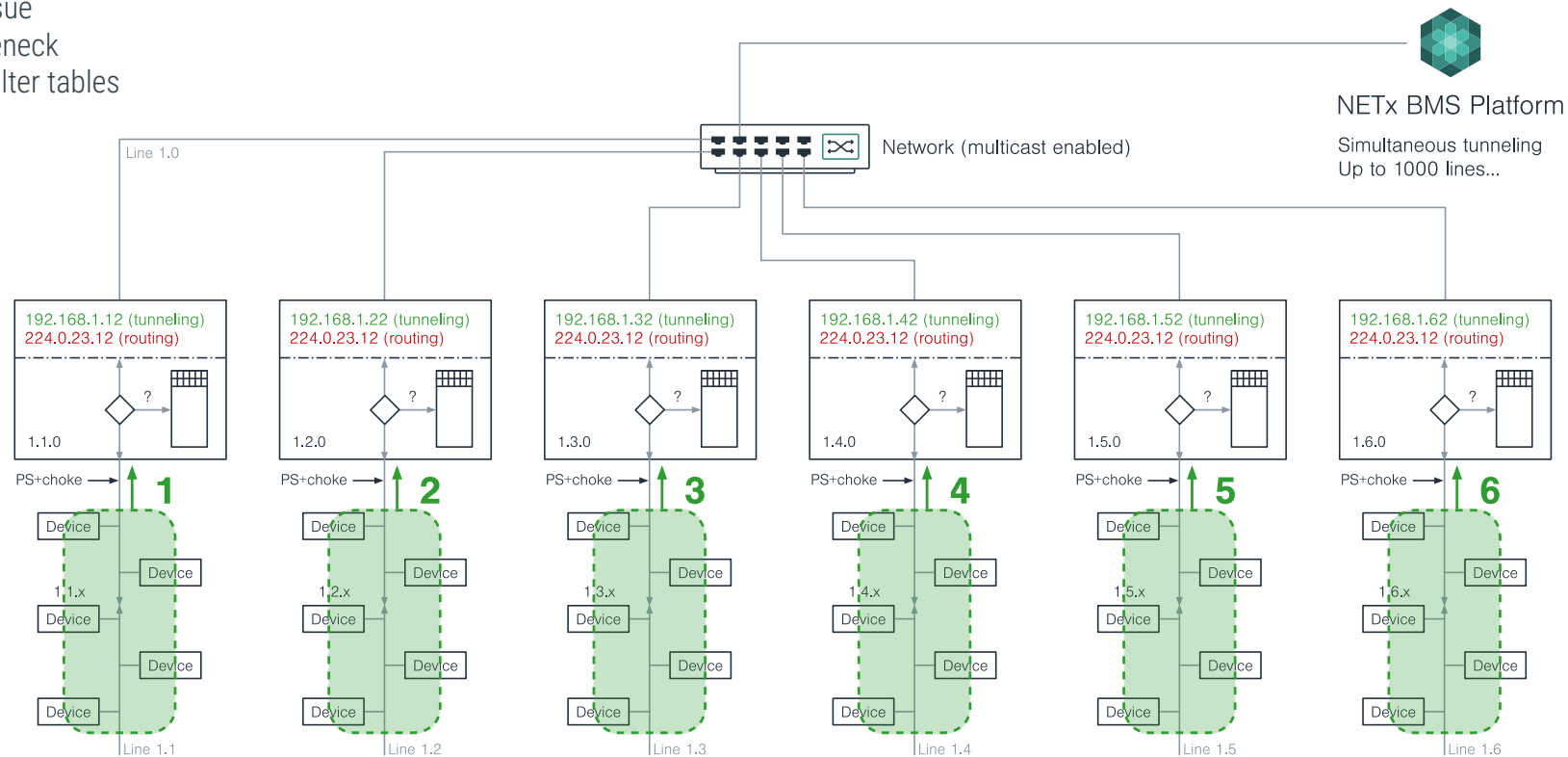

# Defence in depth in hotel projects

Insecure integration

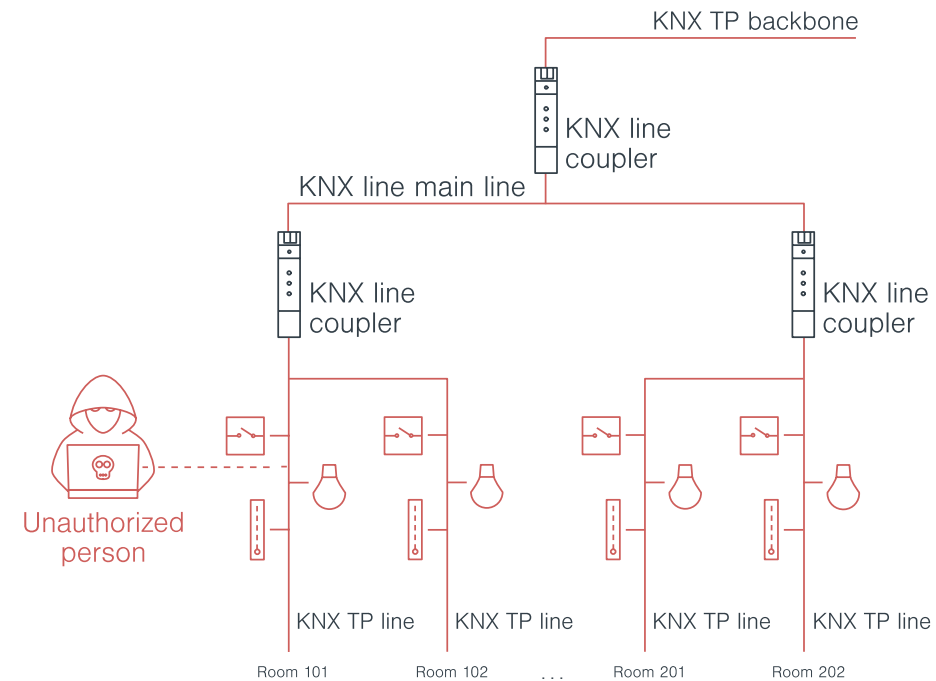



# Intrusion detection with BMS

## Device monitoring

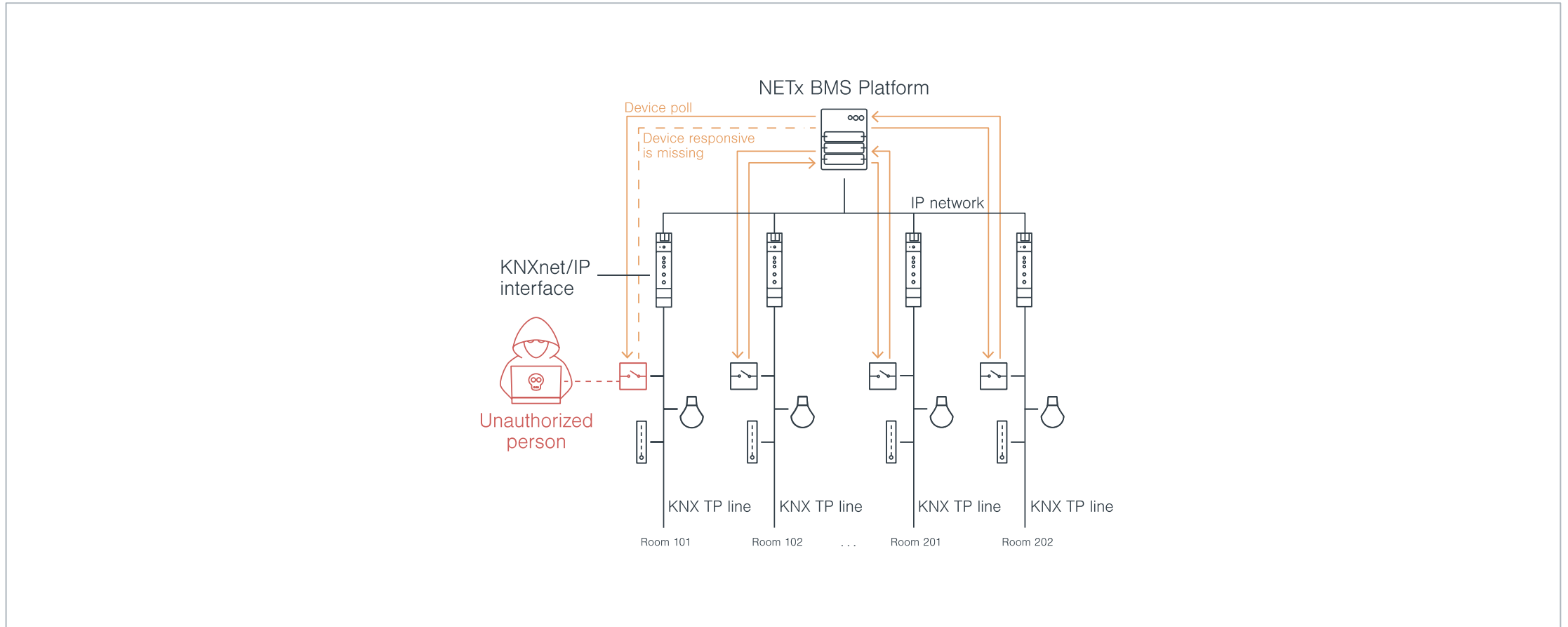

# Contact



## Paul Furtak

CEO

✉ office@netxautomation.com

☎ +43 7242 252900

🌐 Languages: English, German, Polish



## Stefan Baumgartner

Responsibility: Global

✉ stefan.baumgartner@netxautomation.com

☎ +43 7242 252900 40

☎ +43 664 3424610

🌐 Languages: English, German



## Suvankar Das

Responsibility: Asia Pacific Region

✉ suvankar.das@netxautomation.com

☎ +91 983 4810117

🌐 Languages: English, Hindi



## Julio Díaz García

Responsibility: Spain and South America

✉ julio.diaz@netxautomation.com

☎ +34 985 099 660

☎ +34 676 545 700

🌐 Languages: English, Spanish

# Links



Software download

<https://www.netxautomation.com/download/software>



License request

<https://www.netxautomation.com/support/license-request>



Knowledge base

<https://netxautomation.atlassian.net/wiki/spaces/NKB/overview?mode=global>



Training videos

<https://www.netxautomation.com/support/training-videos>



Thank you for your attention!

# Sales contact



**Bastian Elsner**

+49 (0) 1628840794

b.elsner@elsner-elektronik.de

Region: Global



**Snehashis Sharma**

Mobile +971 55 28 41 015

s.sharma@elsner-elektronik.de

Region: MENA



**Daniel Oh**

Mobile +65 9661 9778

d.oh@elsner-apac.com

Region: APAC

elsner®  
elektronik

**elsner** | academy

elsner-elektronik.de

+49 (0) 70 33 / 30 945-0  
info@elsner-elektronik.de