

KNX S-B4T-UP

Actuator for 230 V or 24 V

Item numbers 70130, 70131

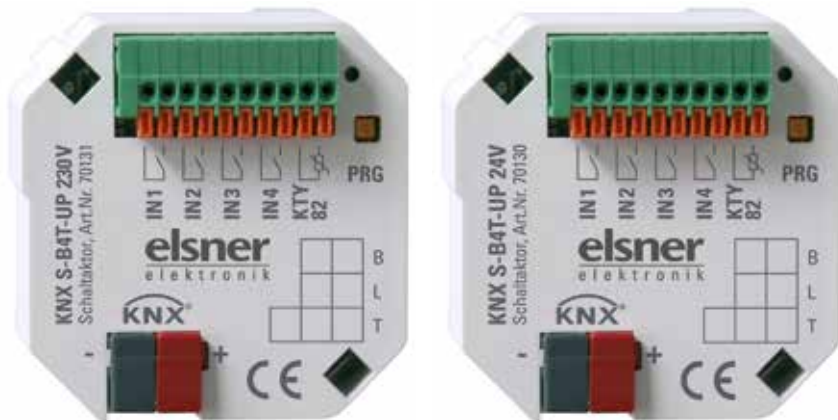

1. Description	3
1.1. Technical data	3
1.2. Structure	4
1.2.1. Structure 230 V AC version	4
1.2.2. Structure 24 V DC version	5
2. Installation and commissioning	5
2.1. Installation notes	5
2.2. Connection	6
2.3. Notes on installation and commissioning	6
3. Transfer protocol	7
3.1. List of all communication objects	7
4. Parameter setting	12
4.1. General settings	12
4.2. Drive	13
4.3. Control	14
4.3.1. Automatic for shading	19
4.3.2. Automatic for windows	24
4.4. Scenes	28
4.5. Actuator button	28
4.6. Bus button	29
4.7. Temperature sensor	33
4.7.1. Threshold value 1 / 2	34
4.8. Connection options for zero position sensors	35



Installation, inspection, commissioning and troubleshooting of the device must only be carried out by a competent electrician.

This manual is amended periodically and will be brought into line with new software releases. The change status (software version and date) can be found in the contents footer. If you have a device with a later software version, please check **www.elsner-elektronik.de** in the menu area "Service" to find out whether a more up-to-date version of the manual is available.

Clarification of signs used in this manual



Safety advice.



Safety advice for working on electrical connections, components, etc.

DANGER!

... indicates an immediately hazardous situation which will lead to death or severe injuries if it is not avoided.

WARNING!

... indicates a potentially hazardous situation which may lead to death or severe injuries if it is not avoided.

CAUTION!

... indicates a potentially hazardous situation which may lead to trivial or minor injuries if it is not avoided.



ATTENTION! ... indicates a situation which may lead to damage to property if it is not avoided.

ETS

In the ETS tables, the parameter default settings are marked by underlining.

1. Description

The **Actuator KNX S-B4T-UP** controls shadings (blinds, awnings, roller shutters) or windows. The automatic for this may be provided externally or internally. An internal automatic offers numerous options for blocking, locking (e. g. master–slave) and priority settings (e. g. manual–automatic). Scenes may be stored and recalled via the bus.

Four binary inputs may be used for direct operation (e. g. manual push-buttons) or as bus inputs. There is an additional input for a temperature sensor.

Functions:

- For drive mechanism of **shading** or **window**
KNX S-UP 230 V: For 230 V motor
KNX S-UP 24 V: For 24 V polarity changer motor
- **4 binary inputs**
- **1 temperature sensor input**
- **8 channel scene control** for operating position (for blinds also slat position)
- **Slat tracking** for blinds according to the position of the sun
- **Position memory** (operating position) with a 1 bit object (Storage and recall e. g. with push-button)
- **Position feedback** (operating position, for blinds also slat position)
- Control by **internal or external automatic**
- Setting of the priority of manual or automatic control by time or via communication object
- **Mutual locking** of two drives by means of zero position sensors avoids collisions e. g. of shading and window (master–slave)
- Blocking objects and alarm messages have different priority so that safety functions always are higher-ranking (e. g. wind blocking)

Configuration is made using the KNX software ETS. The **product file** can be downloaded from the Elsner Elektronik homepage on www.elsner-elektronik.de in the “Service” menu.

1.1. Technical data

Housing	Plastic material
Colour	White
Mounting	In-wall (in socket Ø 60 mm, 60 mm deep)
Protection category	IP 20
Dimensions	approx. 50 x 51 x 41 (W x H x D, mm)
Weight	230 V version: approx. 90 g 24 V version: approx. 70 g
Ambient temperature	Operation -20...+70°C, storage -30...+85°C
Ambient air humidity	5...80% R. H., avoid condensation
Operating voltage	Available for 230 V AC or for 24 V DC

Current	At the bus: 10 mA At 24 V DC: 40 mA At 230 V AC: 2 mA AC
Output	1 x Drive mechanism 230 V version: max. 500 W, fused with microfuse T6.3 A 24 V version: max. 50 W
Inputs	4 x Binary input (for potential-free contacts) 1 x Temperature sensor input (for T-KTY82)
Max. cable length	Binary inputs: 50 m Temperature sensor: 10 m
Data output	KNX +/- bus terminal plug
BCU type	Own micro controller
PEI type	0
Group addresses	max. 200
Allocations	max. 200
Communication objects	125

The product conforms with the provisions of EU directives.

1.2. Structure

1.2.1. Structure 230 V AC version

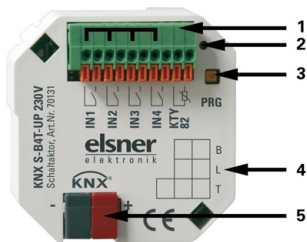

Fig. 1: Front side

- 1 Connecting plug terminal binary Inputs.
1, 3, 5 + 7 (from left) by-passed internally
- 2 Programming LED
- 3 Programming key (PRG)
- 4 Inscription space
- 5 KNX plug terminal +/-

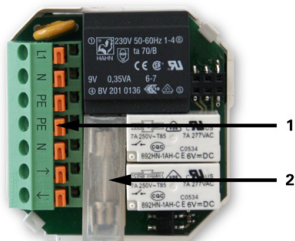

Fig. 2: Rear side

- 1 Connecting plug terminal for voltage supply and drive mechanism
- 2 Microfuse T6,3 A

1.2.2. Structure 24 V DC version

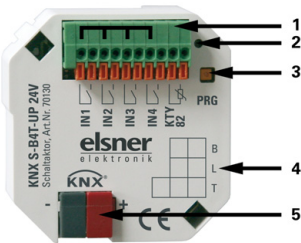

Fig. 3: Front side

- 1 Connecting plug terminal binary In-puts.
1, 3, 5 + 7 (from left) by-passed internal-ly
- 2 Programming LED
- 3 Programming key (PRG)
- 4 Inscription space
- 5 KNX plug terminal +/-

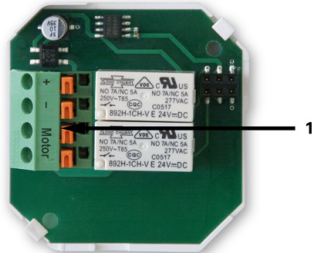

Fig. 4: Rear side

- 1 Connecting plug terminal for voltage supply and drive mechanism

2. Installation and commissioning

2.1. Installation notes



Installation, testing, operational start-up and troubleshooting should only be performed by an electrician.



DANGER!

Risk to life from live voltage (mains voltage)!

There are unprotected live components within the device.

- VDE regulations and national regulations are to be followed.
- Ensure that all lines to be assembled are free of voltage and take precautions against accidental switching on.
- Do not use the device if it is damaged.
- Take the device or system out of service and secure it against unintentional use, if it can be assumed, that risk-free operation is no longer guaranteed.

The device is only to be used for its intended purpose. Any improper modification or failure to follow the operating instructions voids any and all warranty and guarantee claims.

After unpacking the device, check it immediately for possible mechanical damage. If it has been damaged in transport, inform the supplier immediately.

The device may only be used as a fixed-site installation; that means only when assembled and after conclusion of all installation and operational start-up tasks and only in the surroundings designated for it.

Elsner Elektronik is not liable for any changes in norms and standards which may occur after publication of these operating instructions.

2.2. Connection

The actuators are installed in a flush-type socket. The connection is accomplished by a KNX connection clamp at the KNX data bus. Furthermore, a voltage supply (230 V AC or 24 V DC, depending on the version) is necessary. The physical address is allocated by the KNX software. For this purpose, the actuator is provided with a programming key with control LED.

2.3. Notes on installation and commissioning

Never expose actuators to water (rain) or dust. This might damage the electronic system. A relative air humidity of 80% must not be exceeded. Avoid bedewing.

After the auxiliary voltage has been applied, the device will enter an initialisation phase lasting a few seconds. During this phase no information can be received or sent via the bus.

For KNX devices with safety functions (e.g. wind or rain blocks), it is important to establish periodical monitoring of the safety objects. The optimal ratio is 1:3 (example: if the weather station sends a value every 5 minutes, the actuator must be configured for a monitoring period of 15 minutes).

3. Transfer protocol

3.1. List of all communication objects

Abbreviations flags:

K Communication

L Read

S Write

Ü Transfer

No.	Name	Function	Flags	DP Type
0	Manual long term	Input	KL S	1.008
1	Manual short term	Input	KL S	1.007
2	Manual movement position	Input	KL S	5.001
3	Manual slat position	Input	KL S	5.001
4	Automatic long term	Input	KL S	1.008
5	Automatic short term	Input	KL S	1.007
6	Automatic movement position	Input	KL S	5.001
7	Automatic slat position	Input	KL S	5.001
8	Status automatic or manual	UNIT1 Output	KL Ü	1.002
9	Current movement position	UINT8 Output	KL Ü	5.001
10	Current slat position	UINT8 Output	KL Ü	5.001
11	Calling / saving scenes	Input	KL S	18.001
12	Alarm object	Input	KL S	1.003
13	Blocking object 1	Input	KL S	1.003
14	Wind blocking object	Input	KL S	1.003
15	Wind block measurement value	Input	KL S	9.005
16	Wind blocking status	Input	KL Ü	1.002
17	Blocking object 2	Input	KL S	1.003
18	Rain blocking object	Input	KL S	1.003
19	Switch from manual to automatic	Input	KL S	1.002
20	Automatic blocking object	Input	KL S	1.003
21	Outdoor temperature blocking object	UNIT1 Input	KL S	1.003
22	Outdoor temperature blocking measurement value	UNIT16 Input	KL S	9.001
23	Outdoor temperature blocking status	UNIT1 Output	KL Ü	1.002

No.	Name	Function	Flags	DP Type
24	Twilight object	UNIT1 Input	KL S	1.003
25	Twilight measurement value	UNIT16 Input	KL S	9.004
26	Twilight status	UNIT1 Output	KL Ü	1.002
27	Time control	UNIT1 Input	KL S	1.002
28	Indoor temperature release object	UNIT1 Input	KL S	1.003
29	Indoor temperature release Measurement value	UNIT16 Input	KL S	9.001
30	Indoor temperature release target value	UNIT16 Input	KL S	9.001
31	Indoor temperature release status	UNIT1 Output	KL Ü	1.002
32	Shading object	UNIT1 Input	KL S	1.003
33	Shading brightness measurement value 1	UNIT16 Input	KL S	9.004
34	Shading brightness measurement value 2	UNIT16 Input	KL S	9.004
35	Shading brightness measurement value 3	UNIT16 Input	KL S	9.004
36	Shading threshold value	UNIT16 Input / output	KL SÜ	9.004
37	Shading threshold value 1 = Up / 0 = Down	UNIT1 Input	KL S	1.007
38	Shading threshold value Up	UNIT1 Input	KL S	1.017
39	Shading threshold value Down	UNIT1 Input	KL S	1.017
40	Shading status	UNIT1 Output	KL Ü	1.002
41	Shading position teaching object	UNIT1 input	KL S	1.017
42	Azimuth	UNIT16 Input	KL S	9.*
43	Elevation	UNIT16 Input	KL S	9.*
44	Cold air supply blocking object	UNIT1 Input	KL S	1.003
45	Cold air supply outdoor temperature Measurement value	UNIT16 Input	KL S	9.001
46	Cold air supply blocking status	UNIT1 Output	KL Ü	1.002
47	Forced ventilation	UNIT1 Input	KL S	1.002
48	Warm air supply blocking object	UNIT1 Input	KL S	1.003
49	Warm air supply indoor temperature Measurement value	UNIT16 Input	KL S	9.001
50	Warm air supply outdoor temperature measurement value	UNIT16 Input	KL S	9.001
51	Warm air supply blocking target value	UNIT16 Input	KL S	9.001
52	Warm air supply blocking status	UNIT1 Output	KL Ü	1.002

No.	Name	Function	Flags	DP Type
53	Indoor temperature opening object	UNIT1 Input	KL S	1.003
54	Indoor temperature opening measurement value	UNIT16 Input	KL S	9.001
55	Indoor temperature opening target value	UNIT16 Input	KL S Ü	9.001
56	Indoor temperature opening Threshold value	UNIT16 Input / output	KL S	9.001
57	Indoor temperature opening Threshold value 1=Up / 0=Down	UNIT1 Input	KL S	1.007
58	Indoor temperature opening Threshold value Up	UNIT1 Input	KL S	1.017
59	Indoor temperature opening Threshold value Down	UNIT1 Input	KL S	1.017
60	Indoor temperature opening status	UNIT1 Output	KL Ü	1.002
61	Indoor humidity opening object	UNIT1 Input	KL S	1.003
62	Indoor humidity opening measurement value	UNIT16 Input	KL S	9.007
63	Indoor humidity opening status	UNIT1 Output	KL Ü	1.002
64	Zero position reached	UNIT1 Input	KL S	1.002
65	Zero position sensor malfunction object	UNIT1 Output	KL Ü	1.002
66	Master zero position status	UNIT1 Output	KL Ü	1.002
67	Master zero position command	UNIT1 Output	KL Ü	1.002
68	Slave zero position status	UNIT1 Input	KL S	1.002
69	Master zero position status	UNIT1 Input	KL S	1.002
70	Master zero position command	UNIT1 Input	KL S	1.002
71	Slave zero position status	UNIT1 Output	KL Ü	1.002
72	Button 1 Long term	UNIT1 Output	KL Ü	1.008
73	Button 1 Short term	UNIT1 Output	KL Ü	1.007
74	Button 1 Switching	UNIT1 Input / output	KL S Ü	1.001
75	Button 1 Dim relative	UNIT4 Input / output	KL S Ü	3.007
76	Button 1 Encoder 8 bit	UNIT8 Output	KL Ü	5.010
77	Button 1 Encoder temperature	UNIT16 Output	KL Ü	9.001
78	Button 1 Encoder brightness	UNIT16 Output	KL Ü	9.004
79	Button 1 Scene	UNIT8 Output	KL Ü	18.001
80	Button 2 Long term	UNIT1 Output	KL Ü	1.008
81	Button 2 Short term	UNIT1 Output	KL Ü	1.007

No.	Name	Function	Flags	DP Type
82	Button 2 Switching	UINT1 Input / output	KL SÜ	1.001
83	Button 2 Dim relative	UINT4 Input / output	KL SÜ	3.007
84	Button 2 Encoder 8 bit	UINT8 Output	KL Ü	5.010
85	Button 2 Encoder temperature	UNIT16 Output	KL Ü	9.001
86	Button 2 Encoder brightness	UNIT16 Output	KL Ü	9.004
87	Button 2 Scene	UINT8 Output	KL Ü	18.001
88	Button 3 Long term	UNIT1 Output	KL Ü	1.008
89	Button 3 Short term	UNIT1 Output	KL Ü	1.007
90	Button 3 Switching	UINT1 Input / output	KL SÜ	1.001
91	Button 3 Dim relative	UINT4 Input / output	KL SÜ	3.007
92	Button 3 Encoder 8 bit	UINT8 Output	KL Ü	5.010
93	Button 3 Encoder temperature	UNIT16 Output	KL Ü	9.001
94	Button 3 Encoder brightness	UNIT16 Output	KL Ü	9.004
95	Button 3 Scene	UINT8 Output	KL Ü	18.001
96	Button 4 Long term	UNIT1 Output	KL Ü	1.008
97	Button 4 Short term	UNIT1 Output	KL Ü	1.007
98	Button 4 Switching	UINT1 Input / output	KL SÜ	1.001
99	Button 4 Dim relative	UINT4 Input / output	KL SÜ	3.007
100	Button 4 Encoder 8 bit	UINT8 Output	KL Ü	5.010
101	Button 4 Encoder temperature	UNIT16 Output	KL Ü	9.001
102	Button 4 Encoder brightness	UNIT16 Output	KL Ü	9.004
103	Button 4 Scene	UINT8 Output	KL Ü	18.001
104	Temperature sensor malfunctioning	UNIT1 Output	KL Ü	1.002
105	External measurement value	UNIT16 Input	KL S	9.001
106	Internal measurement value	UNIT16 Output	KL Ü	9.001
107	Total measurement value	UNIT16 Output	KL Ü	9.001
108	Requirement min / max temperature	UNIT1 Input	KL S	1.017
109	Lowest temperature measurement value	UNIT16 Output	KL Ü	9.001
110	Highest temperature measurement value	UNIT16 Output	KL Ü	9.001
111	Reset min / max temperature	UNIT1 Input	KL S	1.017

No.	Name	Function	Flags	DP Type
112	Temperature threshold value 1	UINT16 Input / output	KL SÜ	9.001
113	Temperature threshold value 1 1 = Up / 0 = Down	UNIT1 Input	KL S	1.007
114	Temperature threshold value 1 Up	UNIT1 Input	KL S	1.017
115	Temperature threshold value 1 Down	UNIT1 Input	KL S	1.017
116	Temperature threshold value 1 Blocking object	UNIT1 Input	KL S	1.003
117	Temperature threshold value 1 switch output	UNIT1 Output	KL Ü	1.002
118	Temperature threshold value 2	UINT16 Input / output	KL SÜ	9.001
119	Temperature threshold value 2 1 = Up / 0 = Down	UNIT1 Input	KL S	1.007
120	Temperature threshold value 2 Up	UNIT1 Input	KL S	1.017
121	Temperature threshold value 2 Down	UNIT1 Input	KL S	1.017
122	Temperature threshold value 2 Blocking object	UNIT1 Input	KL S	1.003
123	Temperature threshold value 2 Switch output	UNIT1 Output	KL Ü	1.002
124	Software_Version	Readable	KL	5.010

4. Parameter setting

The default settings of the parameter are labeled by an underscore.

4.1. General settings

Actuator controls	<u>Shutter</u> • blinds • awning • window
Use scenes (see chapter <i>Scenes</i> , page 28)	<u>No</u> • Yes
Use input 1 / 2 / 3	No • <u>as bus button</u> • <u>as actuator button</u>
Use input 4	No • as bus button • <u>as actuator button</u> • as zero position sensor
Send error message if zero sensor position is defective (only if input 4 is used as zero position sensor)	<u>No</u> • Yes
Send delay of threshold values after voltage returns	<u>5 s</u> ... 2 h
Send delay of switching and status outputs after voltage returns	<u>5 s</u> ... 2 h
Use temperature sensor (see chapter <i>Temperature sensor</i> , page 33)	<u>No</u> • Yes

4.2. Drive

First set the general specifications for the drive.

Driving direction:

Up/down, on/off or open/close can be exchanged.

Exchange UP/DOWN (<i>shutter, blinds</i>)	<u>no</u> • yes
Exchange ON/OFF (<i>awning</i>)	
Exchange OPEN/CLOSE (<i>window</i>)	

Runtime:

The runtime between the end positions is the basis for moving into intermediate positions (e.g. for movement range limits and scenes).

Runtime DOWN in sec (<i>shutter, blinds</i>)	1 ... 320; <u>60</u>
Runtime OFF in sec (<i>awning</i>)	
Runtime UP in sec (<i>window</i>)	
Runtime OPEN in sec (<i>shutter, blinds</i>)	1 ... 320; <u>65</u>
Runtime ON in sec (<i>awning</i>)	
Runtime CLOSE in sec (<i>window</i>)	

Runtime zero position and step setting of slats:

(only for shutters)

Through the runtime in which the drive continues moving in the zero position (i.e. after reaching the top end position), different curtain lengths or assembly positions of the end position switch may be balanced. The shading of a facade is completely retracted by adjusting the zero position runtimes, and thus provides a better overall image.

Step time x step number determines the turning time of the slats.

Runtime zero position in 0.1 sec	<u>0</u> ... 255
Step time in 10 ms	1 ... 100; <u>20</u>
Step number slats	1 ... 255; <u>5</u>

Break time:

The required break times during a change of direction of the drive should be adjusted according to the specifications of the motor manufacturer.

Break time for a change of direction in 0.1 sec	5 ... 100; <u>10</u>
---	----------------------

Reference movement:

With the regular movement to the two end positions, the runtime and zero position are adjusted again. Here it will be adjusted after how many movements before a positioning movement a reference movement will be completed. The reference movement is always in the direction of the secure position (retracting when shading, closing windows).

Perform a reference movement	<u>no</u> • yes
------------------------------	-----------------

Perform a reference movement	yes
for more than movements before an auto positioning movement	1 ... 255; <u>10</u>

Slat turning:*(only for shutters)*

The slat turning should be adjusted according to the specifications of the motor manufacturer.

Turn slats	<ul style="list-style-type: none"> • <u>never</u> • only after positioning movement • after each movement
------------	--

Drive position:

The current position can be sent to the bus. The adjustable delay ensures that for a longer drive not too many data packages block the bus.

Send drive position after change	<u>no</u> • yes
----------------------------------	-----------------

Send drive position after change	yes
Sending delay of position in 0.1 sec	0...50; <u>10</u>

4.3. Control

Set the behavior of the drive here.

Movement range limit:

The operating range limit is used in order to avoid that two units collide with each other (e.g. an awning and a window which is about to open).

One of two drive mechanisms is prioritised and is parameterised as master and the other one as slave. By means of zero position sensors, both actuators know the own current status and the current status of the other one. This one is either “in a safe position” or “not in a safe position”. The safe position is reached as soon as the drive mechanism is in a sector where a collision is not possible (for an awning, for example, this might be an extension of 0 to 30%). In order to report the safe position of the drive mechanism, either a zero position sensor (e.g. final position switch or light barrier) may be connected at an input of the actuator, or the actuator receives the message of its zero position sensor by the bus (see graphic in chapter *Connection options for zero position sensors* in the general part).

Before the drive mechanism of the master actuator is moved, the slave actuator receives the command to move its drive mechanism to the safe position. As a consequence, the slave remains in safe position or it moves back if it is not within the safe range.

The master actuator knows from the communication object „Slave zero position status” whether the drive mechanism connected to the slave actuator is already in a safe position (then the master moves immediately) or not (then the master waits). Only

if the master actuator is informed that the slave drive mechanism is in a safe position, it moves its drive mechanism beyond its own safe position.

Example:

The ventilation with the window shall take priority over the shading with the awning. Therefore, the window is parameterised as master, the awning as slave. Both are provided with a zero position sensor which reports whether the drive mechanism is in a safe position or not.

The awning is now extended and the window shall be opened. The window knows the status of the awning ("not safe position") and therefore submits a master command to the awning. This is the signal for the awning, to retract a little bit. As soon as the awning has reached a safe position, there is an according feedback signal of the zero position sensor of the awning. Only now the window opens.



Master and slave regularly exchange their positions ("safe" or "not safe"). By means of the monitoring period, you may adjust the frequency of information retrieval. The selected period should be shorter than the period which the monitored drive mechanism needs to travel from the limit of the safe range (last reported safe position) to a position where there is risk of collision.

If the drive mechanism does not receive a master/slave or zero position object, it moves to the safe position. The same holds true for a bus voltage breakdown or for a malfunction message from the zero position sensor (is valid for the parameterisation as master and as slave).

Without movement range limitation:

Use movement range limit	no
Behavior for bus voltage failure	<ul style="list-style-type: none"> • <u>no action</u> • stop • Up-command • Down-command

With movement range limit:

The movement range limit is used automatically, as soon as input 4 is configured as zero position sensor.

If not obtaining a master/slave status or zero position object and in the event of a bus voltage failure the drive will move into a safe position.

Use movement range limit	yes
Actuator is	<u>Master</u> • Slave

Actuator as master:

Actuator is	Master
-------------	---------------

Send repetition for master (-status and) command in sec	1 ... 255; <u>10</u>
Monitoring period for (zero position object and) slave status in sec	1 ... 255; <u>10</u>

Actuator as slave:

Actuator is	Slave
Send repetition for slave commands in sec	1 ... 255; <u>10</u>
Monitoring period for (zero position object and) slave status in sec	1 ... 255; <u>10</u>
Movement position for slave in % if input "Master zero position command" = 1	<u>0</u> ... 100

Monitoring of alarm and blocking objects:

Monitoring of alarm and blocking objects use	<u>No</u> • Yes
--	-----------------

Monitoring of alarm and blocking objects use	Yes
Monitoring period for alarm/blocking objects	5s ... 2h; <u>5 min</u>
Behavior if not obtaining an alarm/blocking object	<u>Stop</u> • Up command • Down command (for shutter/blinds) <u>Stop</u> • Retract command • Extend command (for awning) <u>Stop</u> • Close command • Open command (for window)

The priorities of the blocking objects correspond to the sequence listed (alarm object has the highest priority, the rain blocking the lowest). Block alarm and blocking object at 1.

Alarm object:

For the alarm object it is specified what happens for object value 1 and 0. This way for example a fire alarm scenario can be configured (creating escape routes by retracting the shading, smoke extraction via windows).

Use alarm object	Yes
------------------	------------

Use alarm object	<u>No</u> • Yes
If alarm object has value =1	<ul style="list-style-type: none"> • no action • stop • <u>Up-command</u> • Down-command (shutter/blinds) • <u>Retract-command</u> • Extend-command (awning) • <u>Close-command</u> • Open-command (window)
If alarm object has value =0	
For manual operation before and after alarm	<ul style="list-style-type: none"> • <u>no action</u> • move into last position
For automatic operation after alarm	follow automatic
Value of object before 1st communication and bus voltage return	0... <u>1</u>

Blocking object 1/2:

For the blocking object it is specified what happens for object value 1 and 0. This can for example prevent being locked out on the patio (opened window contact of the patio door blocks the shutter in front of the door).

Use blocking object	Yes
Use blocking object	<u>No</u> • Yes
If blocking object has value =1	<ul style="list-style-type: none"> • no action • stop • <u>Up-command</u> • Down-command (shutter/blinds) • <u>Retract-command</u> • Extend-command (awning) • <u>Close-command</u> • Open-command (window)
If blocking object has value =0	
For manual operation before and after blocking	<ul style="list-style-type: none"> • <u>no action</u> • move into last position
For automatic operation after blocking	follow automatic
Value of object before 1st communication and bus voltage return	0... <u>1</u>

Wind blocking:

The input object "wind blocking" is linked with the output object of a wind sensor. The input can be a 1bit object (smaller or larger than a threshold value), as well as a 16bit object (measurement value).

When blocking the shutter moves up / the awning retracts / the window closes.

Use wind blocking	Yes
Type of input object	<u>1 bit</u> • 16 bit
As of wind speed in m/s blocking (only for 16 bit input object)	2...30; <u>5</u>
Waiting period in secure position in min after wind blocking	1...255; <u>5</u>
Behavior after waiting period	
For manual operation before and after blocking	<ul style="list-style-type: none"> • <u>no action</u> • move into last position
For automatic operation after blocking	follow automatic
Send current blocking status (only for 16 bit input object)	<u>no</u> • yes

Priority rain blocking or manual operation:

Priority is	<u>rain before manual</u> • manual before rain
-------------	--

Rain blocking:

The input object "rain blocking" is linked with the output object of a rain sensor.

When blocking the shutter moves up / the awning retracts / the window closes.

Use rain blocking	Yes
Waiting period in secure position in min after rain blocking	1...20; <u>5</u>
Behavior after waiting period	
For manual operation before and after blocking	<ul style="list-style-type: none"> • <u>no action</u> • move into last position
For automatic operation after blocking	follow automatic

Automatic reset:

With the manual operation the automatic of the drive is deactivated. Here it is set when the automatic is reactivated.

Manual switches to automatic after	<ul style="list-style-type: none"> • <u>expiration of a waiting period</u> • receiving an object • expiration of a waiting period or receipt of an object
Waiting period in min (if "Expiration of a waiting period" was chosen)	1...255; <u>20</u>
Switch to automatic for an object value (if "Receipt of an object" was chosen)	0 • <u>1</u> • 0 or 1

Automatic blocking object:

With the automatic blocking object, the automatic can be deactivated for a short term (e.g. if present or during speeches in conference rooms).

Here it is also specified in which mode the actuator is found when the voltage returns, i.e. after a power failure. The mode (manual or automatic) is send as a status object to the bus.

Use automatic blocking object	<u>no</u> • yes
Operating mode after voltage returns	• <u>Automatic</u> • Manual
Send status object	• <u>1 for automatic 0 for manual</u> • 0 for automatic 1 for manual
Send delay of the status output Automatic or manual in 0.1 sec	<u>0...50</u>

Type of automatic:

The automatic for the connected drive can be specified externally, however all the setting can also be configured internally. If "internal automatic" is chosen, a separate menu item "Automatic" (see chapter Automatic for Shading or Automatic for Windows) appears.

Type of automatic	<u>external automatic</u> • internal automatic
-------------------	--

4.3.1. Automatic for shading

The menu item "Automatic" only appears if internal automatic is selected for "Control". The internal automatic functions take into account the brightness/position of the sun, outdoor and indoor temperature and allow a time and dimming control. A shading position can be specified or taught.

To be able to fully utilize the internal shading automation, information about brightness/twilight, outdoor and indoor temperature, time and position of the sun must be present in the bus system (e.g. data from the Elsner weather stations Suntracer KNX or Suntracer KNX-GPS).

Outdoor temperature block:

The input object "outdoor temperature block" is linked with the output object of a temperature sensor. The input object can be a 1bit object (smaller or larger than a threshold value), as well as a 16bit object (measurement value).

Use automatic blocking object	<u>no</u> • yes
Use automatic blocking object	yes
Type of temperature input object	<u>1 bit</u> • 16 bit

1 bit input object:

Type of temperature input object	1 bit
----------------------------------	--------------

Shading is allowed if the bit is 0 and blocked if the bit is 1.

16bit input object:

Type of temperature input object	16bit
Threshold value in 0.1°C	-300 ... 800; <u>50</u>
Hysteresis in 0.1°C	1 ... 100; <u>20</u>
Send current blocking status	<u>no</u> • yes

Shading is allowed if the measurement value is larger than the threshold value+hysteresis and blocked if the measurement value is smaller than the threshold value.

Twilight/time control:

The time control is provided via a communication object. The input object "twilight control" is linked with the output object of a brightness sensor. A 1bit object (smaller or larger than a threshold value), as well as a 16bit object (measurement value) can be used for the twilight control.

Use twilight/time control	<ul style="list-style-type: none"> • <u>no</u> • only twilight control • only time control • both (OR linking)
---------------------------	--

Use twilight/time control	only twilight control / both
Type of twilight object	<u>1 bit</u> • 16 bit

16bit input object:

Type of twilight object	16bit
Twilight threshold value in lux	1 ... 1000; <u>10</u>
Switching delay	1 minute
Send current twilight status	<u>no</u> • yes

Indoor temperature release:

The input object "indoor temperature release" is linked with the output object of a temperature sensor. The input object can be a 1bit object (smaller or larger than a threshold value), as well as a 16bit object (measurement value or target and actual value).

Use inside temperature release	<u>no</u> • yes
--------------------------------	-----------------

Type of input object	<u>1 bit</u> • 16 bit • 16bit target/actual temperature
----------------------	---

16bit input object:

Type of input object	16bit
Threshold value in 0.1°C	-300 ... 800; <u>200</u>

Hysteresis in 0.1°C	1 ... 100; <u>20</u>
Send current blocking status	<u>no</u> • yes

Shading is allowed if the measurement value is greater or equal to the threshold value and blocked if the measurement value is smaller than the hysteresis threshold value.

16bit input object (target/actual temperature):

For this function the target value and actual value (measurement value) are imported from the 16bit object and evaluated.

Type of input object	16bit target/actual temperature
Target value (SW) – actual value (MW) Difference in 0.1°C	1 ... 100; <u>20</u>
Hysteresis in 0.1°C	1 ... 100; <u>20</u>
Send current blocking status	<u>no</u> • yes

Shading is allowed if the measurement value is greater than or equal to the target value difference and blocked if the measurement value is smaller than the target value + difference of hysteresis.

Automatic shading:

The automatic shading evaluates the input objects "brightness" and "position of the sun" of a weather station. The moving position for the automatic shading is specified here as well.

Use automatic shading	<u>no</u> • yes
-----------------------	-----------------

Brightness:

For controlling brightness, a 1bit object (smaller or larger than a threshold value), as well as two or three 16bit objects (measurement values, e.g. East, South and West sun) can be used.

Type of shading input	<u>1 x 1 bit</u> • 1 x 16 bit • 2 x 16 bit • 3 x 16 bit
-----------------------	---

1 x 1 bit input object:

Set the delay times for shading (prevents constant opening and closing when light conditions change quickly).

Type of shading input	1 x 1 bit
Drive up delay in min	0 ... 255; <u>12</u>
Departure delay in min	0 ... 30; <u>1</u>

1 x 16 bit, 2 x 16 bit or 3 x 16 bit as an input object:

The brightness threshold value can be specified per parameter or communication object. For several brightness measurement values (2 x 16 bit or 3 x 16 bit) only the maximum brightness value is compared to the threshold value.

Type of shading input	1 x 16 bit • 2 x 16 bit • 3 x 16 bit
Shading threshold specification per	<u>parameter</u> • communication object

Threshold value per parameter:

Set the threshold value and delay times for shading (prevents constant opening and closing when light conditions change quickly).

Shading threshold specification per	Parameter
Shading threshold value in klux	0 ... 100; <u>30</u>
Drive up delay in min	0 ... 255; <u>12</u>
Drive down delay in min	0 ... 30; <u>1</u>
Send current shading status	<u>No</u> • Yes

Threshold value per communication object:

The threshold value is received via the communication object and can be changed additionally (e.g. button for "more sensitive" and "less sensitive"). Set the delay times for shading here (prevents constant opening and closing when light conditions change quickly).

Shading threshold specification per	communication object
The value communicated last shall be retained	<ul style="list-style-type: none"> • <u>not</u> • after voltage returns • after voltage returns and programming
Start threshold value in klux valid until 1st communication	0 ... 100; <u>30</u>
Type of limit value change	<ul style="list-style-type: none"> • <u>Absolute value with a 16bit comm. object</u> • Lifting/lowering with a comm. object • Lifting/lowering with two comm. objects
Increments in klux (only when "lifting/lowering with comm. object")	1 ... 5; <u>2</u>
Drive up delay in min	0 ... 255; <u>12</u>
Drive down delay in min	0 ... 30; <u>1</u>
Send current shading status	<u>no</u> • yes

Position of the sun:

Assess position of the sun	<u>no</u> • yes
Assess position of the sun	yes
Position of the sun is defined via	<ul style="list-style-type: none"> • <u>Discreet value of azimuth and elevation</u> • Directions (regarding azimuth and elevation)

Defining position of sun via values:

Enter the range (direction and height) in which the sun must be located for the shading to be active.

Position of the sun is defined via	discreet value of azimuth and elevation
Azimuth from	<u>0</u> ... 360

Azimuth to	<u>0</u> ... 360
Elevation from	<u>0</u> ... 90
Elevation to	<u>0</u> ... 90

Defining position of the sun via directions:

Enter the direction in which the sun must be positioned so that the shading is active.

Position of the sun is defined via	directions (regarding azimuth and elevation)
Directions	<ul style="list-style-type: none"> • East (azimuth: 0° ... 180°) • South east (azimuth: 45° ... 225°) • South (azimuth: 90° ... 270°) • South west (azimuth: 135° ... 315°) • West (azimuth: 180° ... 360°)

Slats and moving position (for shutters):

For shutters the angle of the slats can be firmly set, or the slats can automatically follow the elevation. This rule applies: Slats are closed at 100%, horizontal at 50%.

Should the slats follow the elevation	<u>no</u> • yes
---------------------------------------	-----------------

The slats should **not** follow the elevation (fixed reversing angle):

Adjust the desired position of the slats and the curtain.

Should the slats follow the elevation	no
Slat position in %	0 ... 100; <u>75</u>
Shutter position in %	0 ... 100; <u>75</u>
Use teaching object for new shading position (curtain and slat positions will be saved, see info below)	<u>no</u> • yes

The slats shall follow the elevation:

Three different elevation ranges can be set. A fixed curtain and slat position is specified for each.

Should the slats follow the elevation	yes
For an elevation less than (in degrees)	0 ... 90; <u>10</u>
Slat position in %	0 ... 100; <u>95</u>
otherwise	0 ... 100
Slat position in %	0 ... 100
Shutter position in %	0 ... 100
Use teaching object for new shading position (only the curtain position will be saved, see info below)	<u>no</u> • yes

Moving position (for awnings and blinds):

Awning position in % or blind position in %	0 ... 100; <u>75</u>
Use teaching object for new shading position	<u>no</u> • yes

Use teaching object for new shading position: The curtain position it can be specified numerically or taught manually. For teaching set "use teaching object: Yes" and the "channel X shading position teaching object" is used for saving the position reached. Saving occurs for value = 1 and can for example be realized via a button linked to the teaching object. Numerical specifications already set are overwritten by the teaching object.

4.3.2. Automatic for windows

The menu item "Automatic" only appears if internal automatic is selected for "Control". Depending on the setting, the internal automatic functions take the outdoor temperature, indoor temperature and room air humidity into account, and allow forced ventilation via a communication object.

In order to fully utilize the internal ventilation automatic, information about the outdoor and indoor temperature and the inside air humidity must be present in the bus system.

Cold supply air lock:

The input object "cold supply air block" is linked with the output object of a temperature sensor. The input object can be a 1bit object (smaller or larger than a threshold value), as well as a 16bit object (measurement value).

Use cold supply air block	<u>no</u> • yes
Use cold supply air block	yes
Type of temperature input object	<u>1 bit</u> • 16 bit

1bit input object:

Type of temperature input object	1 bit
----------------------------------	--------------

Ventilation is allowed if the bit is 0 and blocked if the bit is 1.

16bit input object:

Type of temperature input object	16 bit
Threshold value in 0.1°C	-300 ... 800; <u>50</u>
Hysteresis in 0.1°C	1 ... 100; <u>20</u>
Send current blocking status	<u>no</u> • yes

Ventilation is allowed if the measurement value is larger than the threshold value+hysteresis and blocked if the measurement value is smaller than or equal to the threshold value.

Forced ventilation:

Use forced ventilation	<u>no</u> • yes
------------------------	-----------------

If forced ventilation is active ("use forced ventilation: Yes"), ventilation is started as soon as the communication object "forced ventilation" = 1.

Warm supply air block:

The input object "warm supply air block" is linked with the output object of one or more temperature sensors. The input object can be a 1bit object (smaller or larger than a threshold value), as well as a 16bit object (measurement value indoor/outdoor or target and actual value).

Use warm supply air block	<u>no</u> • yes
---------------------------	-----------------

Use warm supply air block	yes
Type of input object	<u>1 bit</u> • 16 bit • 16 bit target/actual temperature

1bit input object:

Type of input object	1 bit
----------------------	--------------

Ventilation is allowed if the bit is 0 and blocked if the bit is 1.

16bit input object:

Type of input object	16 bit
Threshold value in 0.1°C	-100 ... 200; <u>50</u>
Hysteresis in 0.1°C	1 ... 100; <u>20</u>
Send current blocking status	<u>no</u> • yes

Ventilation is allowed if the outdoor measurement value is smaller than the indoor measurement value+difference-hysteresis and blocked if the outdoor measurement value is greater than or equal to the indoor measurement value+difference.

16bit input object (target/actual temperature):

For this function the target value and actual value (measurement values) are imported from the 16bit object and evaluated.

Type of input object	16 bit target/actual temperature
Close if outdoor temperature exceeds the target value by (in 0.1°C)	0...255; <u>50</u>
Hysteresis in 0.1°C	1...100; <u>20</u>
Send current blocking status	<u>no</u> • yes

Ventilation is allowed if the outdoor measurement value is smaller than the target value+difference-hysteresis and blocked if the outdoor measurement value is greater than or equal to the target value+difference.

Open by temperature/humidity:

Open window	<ul style="list-style-type: none"> • <u>never</u> • if too high temperature • if too high room air humidity • if too high temperature or room air humidity
-------------	--

Indoor temperature:

These parameters appear if ventilated at "too high temperature" / "too high temperature or room air humidity". The input object can be a 1bit object (smaller or larger than a threshold value), as well as a 16bit object (measurement value or target and actual value).

Type of temperature input object	<u>1 bit</u> • 16 bit • 16 bit target/actual temperature
----------------------------------	--

1 bit input object:

Type of temperature input object	1 bit
----------------------------------	--------------

Ventilation is activated if the bit is 0 and blocked if the bit is 1.

16 bit input object:

The threshold value specification can be provided via a parameter or communication object.

Type of temperature input object	16 bit
Indoor temperature of threshold specification via	<u>parameter</u> • communication object

Threshold value per parameter:

Indoor temperature of threshold specification via	parameter
Indoor temperature threshold value in 0.1?	-100 ... 500; <u>300</u>
Hysteresis in 0.1?	1 ... 100; <u>20</u>
Send current temperature status	<u>no</u> • yes

Threshold value per communication object:

The threshold value is received via the communication object and can be changed additionally (e.g. button for target temperature + and -).

Indoor temperature threshold specification via	communication object
The value communicated last shall be retained	<ul style="list-style-type: none"> • <u>not</u> • after voltage returns • after voltage returns and programming
Start threshold value in 0.1°C valid until 1st communication	100 ... 500; <u>300</u>

Type of limit value change	<ul style="list-style-type: none"> • <u>Absolute value with a 16bit comm. object</u> • Lifting/lowering with a comm. object • Lifting/lowering with two comm. objects
Increments (only when "lifting/lowering with comm. object")	0.1°C ... 5°C; <u>1°C</u>
Hysteresis in 0.1?	1 ... 100; <u>20</u>
Send current temperature status	<u>no</u> • yes

16 bit input object (target/actual temperature):

For this function the target value and actual value (measurement values) are imported from the 16bit object and evaluated.

Type of temperature input object	16 bit target / actual temperature
Open if actual value exceeds the target value (in 0.1°C)	0...255; <u>20</u>
Hysteresis in 0.1°C	1...100; <u>20</u>
Send current blocking status	<u>no</u> • yes

Room air humidity:

These parameter appear if ventilated at "too high room air humidity" / "too high temperature or room air humidity". The input object can be a 1bit object (smaller or larger than a threshold value), as well as a 16bit object (measurement value).

Type of humidity input object	<u>1 bit</u> • 16 bit
-------------------------------	-----------------------

1 bit input object:

Type of humidity input object	1 bit
-------------------------------	--------------

Ventilation is activated if the bit is 0 and blocked if the bit is 1.

16 bit input object:

Type of humidity input object	16 bit
Indoor humidity threshold value in %	0 ... 100; <u>60</u>
Hysteresis in 0.1°C	1 ... 100; <u>5</u>
Send current humidity status	<u>no</u> • yes

Window opening:

If the ventilation by temperature or humidity is controlled via a 1bit input object, then enter the opening position in %.

Window opening in %	1... <u>100</u>
---------------------	-----------------

If the ventilation is controlled by temperature and humidity via a 16bit input object, then you can either set an opening position or open the windows incrementally. In the

step operation the temperature/humidity deviation is checked after a specified period of time, and may be increased/decreased by one step.

Window opening	<u>absolute in %</u> • incrementally
Window opening in % (only if "window opening is absolute in %")	1... <u>100</u>
incrementally by (in %) (only if "window opening is in increments")	1...100; <u>25</u>
every (in minutes) (only if "window opening is in increments")	1...60; <u>3</u>

4.4. Scenes

The menu item "scenes" appears for "General settings" only if "Use scenes: Yes" is selected.

You can save 8 different movement positions as scenes and call them via the bus. Additionally, you can indicate if for the programming of scenes all, or only the changed settings are transferred to the bus.

Apply for programming	<u>all parameters</u> • only changed parameters
Use scenes	<u>no</u> • yes

You can give each activated scene a unique scene number, regardless of the internal actuator number.

Scene number	<u>0</u> ...127
Shutter position in % or blind position in % or awning position in % or window position in %	0...100; <u>50</u>
slat position in % (only for shutters)	0...100; <u>70</u>

4.5. Actuator button

"Input as actuator button" is chosen for "general settings". The input is used for controlling the drive to this actuator. Specify the button function and the control mode.

Button function	<u>Up</u> • Down <u>Up</u> • Down • <u>Up/</u> Down <u>On</u> • Off • On/Off <u>Open</u> • Closed • Open/Closed	(shutter) (blinds) (awning) (window)
Control mode*	<ul style="list-style-type: none"> • <u>Standard</u> • Standard inverted • Comfort mode • Dead man's switch 	

*A detailed description of the setting options for the individual control modi can be found in chapter *Control modi for drive control*, page 31.

If monitoring periods or movement range limits are used, operation via the button is possible in case of a bus voltage failure.

4.6. Bus button

"Input as bus button" is chosen for "general settings". If an input is used as a free bus button, it will send a previously set value to the bus when activated. In the program file of the actuator **KNX S-B4T-UP** different parameters are integrated for frequently needed bus functions. Thus, the inputs can easily be configured as a switch, drive control, dimmer for sending values and for the scene calling.

Bus function	<ul style="list-style-type: none"> • <u>switch</u> • selector switch • shutter • blinds • awning • window • dimmer • 8 bit encoder • temperature encoder • brightness encoder • scenes
--------------	---

Input as switch:

If a button with switch function is assigned to the input, select the bus function "Switch" and specify which value is sent when pressing/releasing the button and when it will be sent.

Bus function	Switch
Command when pressing the button	<ul style="list-style-type: none"> • send <u>0</u> • <u>send 1</u> • do not send telegram
Command when releasing the button	<ul style="list-style-type: none"> • <u>send 0</u> • send 1 • do not send telegram
Send value	<ul style="list-style-type: none"> • <u>no change</u> • for change to 1 • for change to 0 • for change and cyclical • for change to 1 and cyclical • for change to 0 and cyclical
Send all values (only if sent as "cyclical")	<u>5 s</u> ... 2 h

Input as selector switch:

If a button with switch function is assigned to the input, select the bus function "Selector switch" and specify if the button should switch when pressed/released.

Bus function	Selector switch
Command when pressing the button	<ul style="list-style-type: none"> • <u>selector switch</u> • do not send telegram
Command when releasing the button	<ul style="list-style-type: none"> • selector switch • <u>do not send telegram</u>

Input to shutter, blinds, awning or window control:

If the input to the drive control is used via the bus, select the bus function "shutter", "awning", "blinds" or "window" and specify the button function and control mode.

Bus function	Shutter / blinds / awning / window	
Button function	<u>Up</u> • Down <u>Up</u> • Down • Up/ Down <u>On</u> • Off • On/Off <u>Open</u> • Closed • Open/Closed	(shutter) (blinds) (awning) (window)
Control mode*	<ul style="list-style-type: none"> • Standard • Standard inverted • Comfort mode • Dead man's switch 	

*A detailed description of the setting options for the individual control modi can be found in chapter *Control modi for drive control*, page 31.

Input as dimmer:

If the input is used as a dimmer, select the bus function "Dimmer" and specify the button function, time interval (switching/dimming) and if requested, the repeat interval for a long button press.

Bus function	Dimmer
Button function	<u>brighter</u> • darker • brighter/darker
Time between switching and dimming in 0.1 seconds	1...50; <u>5</u>
Repeat the dimm command	<u>no</u> • yes
Repeat the dimm command for a long button press (only if dimm command is repeated)	every 0.1 s • every 2 sec; <u>every 1 sec</u>
Dim by (only if dimm command is repeated)	1,50% • 3% • <u>6 %</u> • 12,50% • 25% • 50%

Input 8 bit encoder:

If the input is to be used as an 8bit encoder, select the "8 bit encoder" bus function and specify which value will be sent.

Bus function	8 bit encoder
Value	<u>0</u> ...255

Input as temperature encoder:

If the input is used as a temperature encoder, then choose the bus function "Temperature encoder" and specify which value between -30°C and +80°C will be sent. By sending a temperature value, the target value of the temperature control may be changed for example (e.g. Elsner KNX T-UP).

Bus function	Temperature encoder
Temperature in 0.1°C	-300...800; <u>200</u>

Input as brightness encoder:

If the input is assigned and shall be used as a brightness encoder (e.g. switch output of a sun sensor), select "brightness encoder" and specify which value will be sent. By sending a brightness value, the threshold value of the sun sensor may be changed for example (e.g. Elsner KNX L).

Bus function	Brightness encoder
Brightness in klux	0...100; <u>20</u>

Input for scene control:

If scenes are called and saved with the input, then choose the "Scenes" bus function and specify the saving, time difference (call/save) and scene number.

Bus function	Scenes
Button operation	<ul style="list-style-type: none"> • <u>without saving</u> • with saving
Time between calling and saving in 0.1 seconds (only if selected "with saving")	1...50; <u>10</u>
Scene No.	<u>0</u> ...127

Control modi for drive control

If inputs are used as buttons for operating shading or windows, then different control modi can be set.

Control mode	<ul style="list-style-type: none"> • Standard • Standard inverted • Comfort mode • Dead man's switch
--------------	--

Standard:

If briefly operated, the drive will move incrementally or stops. If operated longer, the drive will move up to the end position. The time difference between "short" and "long" is set individually.

Control mode	Standard
Behavior during button operation: short = stop/increment long = Up or Down	
Time between short and long in 0.1 seconds	1...50; <u>10</u>

Standard inverted:

When pushed shortly, the drive moves up to the end position. When pushed for longer, the drive moves incrementally or stops. The time difference between "short" and "long" and the repeat interval is set individually.

Control mode	Standard inverted
Behavior during button operation: short = Up or Down long = Stop/Step	
Time between short and long in 0.1 seconds	1...50; <u>10</u>
Repeat the step command for a long button press	every 0.1 s • every 2 sec; <u>every 0.5 sec</u>

Comfort mode:

In the **comfort mode** pushing the button briefly, a bit longer and long will trigger different responses of the drive. The time intervals are set individually.

By pushing the button (shorter than adjustable time 1) the drive will be positioned (resp. stopped) incrementally.

If the drive is to be moved a bit farther, then a little longer push is needed (longer than time 1 but shorter than time 1+2). The drive stops immediately when releasing the button.

If the drive must be moved independently into the end position, the button is released only after times 1 and 2 have expired. The move can be stopped by briefly pushing.

Fig. 5

Time interval comfort mode diagram

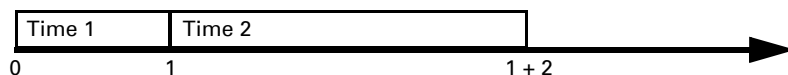

Point in time 0:

Push of button, start of time 1

Release before time 1 expired:

step (or stop if drive is moving)

Point in time 1:

End of time 1, start of time 2

Moving command

Release after time 1 expired

but before time 2 expires:

Stop

Release after time 1 + 2 expired:

Move into end position

Control mode	Comfort mode
Behavior during button operation: Button is pushed and released before time 1 expired = stop/step held longer than time 1 = Up or Down released between time 1 and 1-2= stop released after time 1 +2 = no more stop	
Time 1	0.0s ... • 2 s; <u>0,4 s</u>
Time 2	0 s • 2 s; <u>2 s</u>

Dead man's switch:

The drive moves as soon as the button is pushed and stops as soon as the button is released.

Control mode	Dead man's switch
Behavior during button operation: Push button = Up or Down command Release button = Stop command	

4.7. Temperature sensor

The menu item "scenes" appears only for "General settings" if "Use temperature sensor: Yes" is selected.

For the temperature sensor you can adjust an offset (adjust the measuring value), set a mixed value and specify requirements for sending. Activate the threshold limit here as well.

Temperature offset in 0.1?	-50...50; <u>0</u>
Use external measurement value	<u>No</u> • Yes
Ext. measurement value share of the total measurement value	5%...100%; <u>50%</u>
Internal and total measurement value (<i>only is using an external measurement value</i>)	<ul style="list-style-type: none"> • <u>do not send</u> • send cyclically • send if changed • send for change and if cyclical
The following settings refer to the total measurement value	
as of a temperature change of (<i>only if selected "send if changed"</i>)	<u>2°C</u> • 3 °C • 4°C • 5°C
Transmit measurement value periodically every (<i>only if selected "send periodically"</i>)	<u>5 s</u> ... 0.2 h
Use min. and max. temperature values	<u>No</u> • Yes

For activation the temperature values are not maintained after a reset.	
Use malfunction object	<u>No</u> • Yes
Use threshold value 1 / 2	<u>No</u> • Yes

4.7.1. Threshold value 1 / 2

The menu items "threshold value" appears only if the temperature limit values are activated. A blocking of the switch output is possible.

Threshold value:

Threshold value specification per	<u>parameter</u> • communication object
-----------------------------------	---

Threshold value per parameter:
Set the temperature limit value.

Threshold value specification per	parameter
Threshold value in 0.1°C	-300...800; <u>200</u>
Hysteresis of the threshold value in 0.1°C	0...100; <u>20</u>

Threshold value per communication object:

The threshold value is received via the communication object and can be changed additionally (e.g. button for + and -).

Shading threshold specification per	communication object
The value communicated last shall be retained	<ul style="list-style-type: none"> • <u>not</u> • after voltage returns • after voltage returns and programming
Start threshold value in 0.1°C valid until 1st communication	-300 ... 800; <u>200</u>
Type of limit value change	<ul style="list-style-type: none"> • <u>absolute value with a 16 bit comm. object</u> • raising/lowering with a comm. object • raising/lowering with two comm. objects
Increments (only when "lifting/lowering with comm. object")	0.1°C • 0.2°C • 0.3°C • 0.4°C • 0.5°C • <u>1°C</u> • 2°C • 3°C • 4°C • 5°C
Hysteresis of the threshold value in 0.1°C	0 ... 100; <u>20</u>

Switch output:

Via the switch output, the threshold value excess/fall short are transmitted to the bus.

Output is for (GW=threshold value)	<ul style="list-style-type: none"> • <u>GW above = 1</u> GW - hyst. below = 0 • GW above = 0 GW - hyst. below = 1 • GW below = 1 GW + hyst. above = 0 • GW below = 0 GW + hyst. above = 1
Switching delay from 0 to 1	<u>none</u> • 1 s ... 2 h
Switching delay from 1 to 0	<u>none</u> • 1 s ... 2 h

Switching output sends	<ul style="list-style-type: none"> • <u>no change</u> • for change to 1 • for change to 0 • for change and cyclical • for change to 1 and cyclical • for change to 0 and cyclical
Send all switching output periodically (only if "...and periodically" was selected)	<u>5 s</u> ... 2 h

Blocking:

Use blocking the switching output	<u>No</u> • Yes
Use blocking the switching output	Yes
Evaluation of the blocking object	<ul style="list-style-type: none"> • <u>for value 1: blocking for value 0: release</u> • for value 0: blocking for value 1: release
Value of the blocking object before 1st communication	<u>0</u> • 1
Behavior of the switching output when blocking	<ul style="list-style-type: none"> • <u>do not send telegram</u> • send 0 • send 1
when release (with 2 seconds release delay)	[depending on the setting for "send switching output"]

The behavior of the switching output when releasing depends on the parameter value "Send switching output" (see "Switching output").

Switching output sends if changed	do not send telegram • send status of the switching output
Send switching output for change to 1	do not send telegram • if switching output = 1 ↻ send 1
Send switching output for change to 0	do not send telegram • if switching output = 0 ↻ send 0
Switching output sends when changed and if periodically	send status of the switching output
Send switching output if changed from 1 and periodically	if switching output = 1 ↻ send 1
Send switching output if changed from 0 and periodically	if switching output = 0 ↻ send 0

4.8. Connection options for zero position sensors

See also Section *Movement range limit* in chapter *Control*, page 14. The examples and the communication object numbers refer to the mutual master-slave coupling of drives to the two actuators KNS X-B2-UP.

**Actuator 1 is Master, zero position sensor at actuator 1,
Actuator 2 is Slave, zero position sensor at actuator 2:**

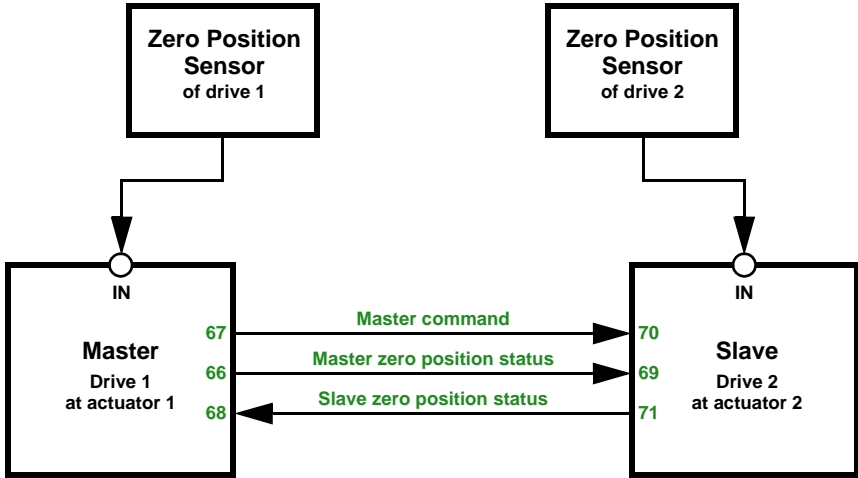

**Actuator 1 is Master, zero position sensor at actuator 1,
Actuator 2 is Slave, zero position sensor via bus:**

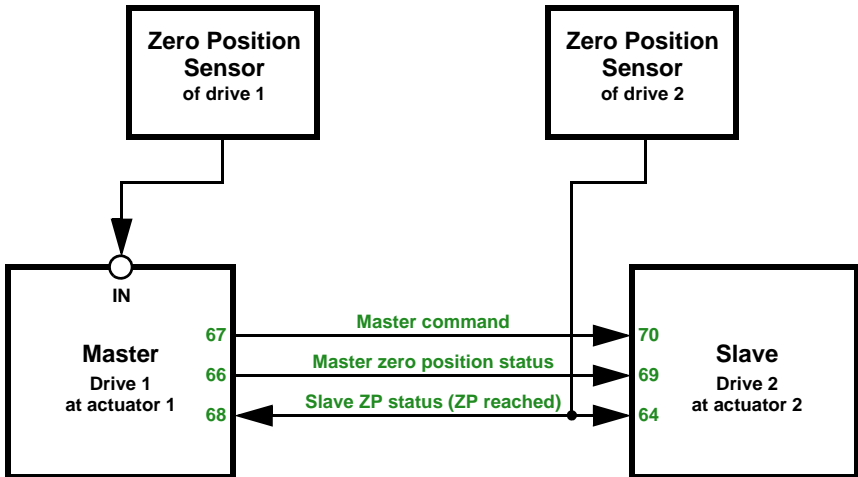

**Actuator 1 is Master, zero position sensor via bus,
Actuator 2 is Slave, zero position sensor at actuator 2:**

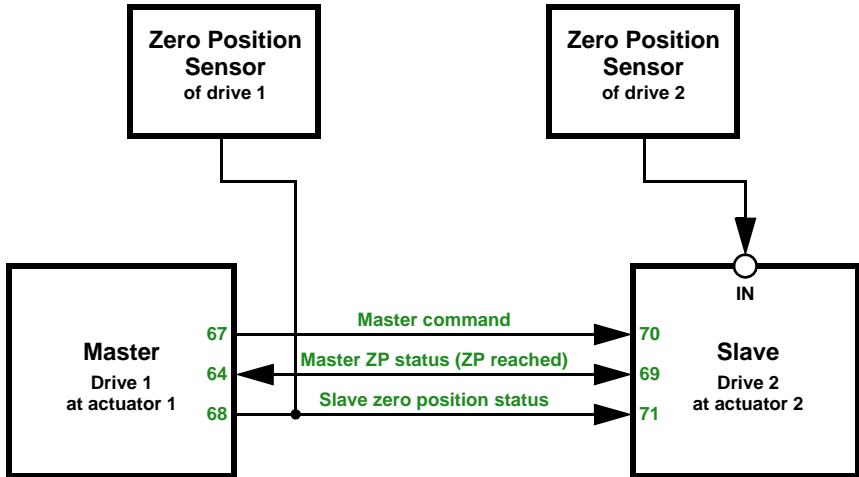

**Actuator 1 is Master, zero position sensor via bus,
Actuator 2 is Slave, zero position sensor via bus:**

