

EN

Arexa 230V

Window Control

Item number 10115



elsner

Installation and Adjustment

Description	3
Installation instructions	3
Commissioning procedure.....	3
Options for connection and control.....	3
Overview of available automatic functions	4
Operation	5
Key functions and display symbols of the meteorological data display.....	5
Display of lightness and wind speed	6
Manual operation	6
Move window manually	7
Switch between manual and automatic.....	7
Central control	8
Settings (default setting, automatic)	8
Installation and Commissioning	9
Installation.....	9
Details for the installation of the weather station.....	9
Commissioning.....	10
Sensor testing.....	11
Sun sensor testing	11
Wind sensor testing	11
Rain sensor testing	12
Temperature sensor testing.....	12
Basic settings	13
1. Radio connection to the weather station	15
Delete all radio connections of the weather station.....	16
2. Rotational direction of the motor.....	16
3. Operating direction	17
4. Operating command in case of wind or rain alarm.....	18
5. Sending of meteorological and automatic data	19
6. Opening position	20
6.1. Closed position	21
6.2. Setting of the desired position	21
7. Saving of basic settings	22
Setting of automatic.....	23
Safety instructions for automatic and alarm functions.....	24
A. Indoor temperature for opening	26
B. Outdoor temperature block.....	27
C. Wind alarm.....	28
Table for wind speeds	28
D. Rain alarm.....	29
E. Storage of automatic settings.....	30

Service	31
<hr/>	
Service and maintenance	31
Power outage.....	31
Insert batteries (operating unit).....	31
Error messages	32
Query service data.....	34
Disposal.....	34
Factory settings.....	34
Connection samples for several drive mechanisms as group.....	34
Connection samples for centralised control with motor control units	35
Personal setting data of the automatic	36

Arexa • from software version operating unit 3.0, Arexa weather station 4.0 • Status: 29.07.2024. Errors excepted. Subject to technical changes.

Description

The Arexa window control system has been developed for the automatic control of a window (or a group of windows) and for comfortable manual operation. The control system offers a highest degree of flexibility for installation and setting and may therefore be adjusted individually to different conditions. Please use this instruction manual in order to adjust the automatic function to your requirements.

Installation instructions

For information on installation, maintenance, disposal, scope of delivery and technical data, please refer to the installation instructions.

Commissioning procedure

Proceed as follows when commissioning the Arexa control system:

1. Installation and connection (see installation instructions)
2. Basic setting (see chapter „Basic settings“)
3. Setting of the automatic (see chapter „Setting of automatic“)

Options for connection and control

A drive mechanism for windows may be connected to the Arexa control system. If several windows shall be controlled together, the connection via a group control relay is possible.

The connected drive (or drive group) may be operated manually with the operating unit. A suitable radio remote control (Remo 8) and a radio push-button interface (RF B2-UP) are available in addition (option).

An operating device and an additional remote control Remo 8 or a pushbutton interface RF-B2-UP can be operated with the weather station (maximum two radio controlled participating devices at the weather station).

The following **environmental parameters** are measured and displayed:

- Outdoor and indoor temperature
- Lightness
- Wind speed
- Precipitation

Overview of available automatic functions

- Open when a selectable indoor temperature is reached
- Close and keep closed below a selectable outdoor temperature (outdoor temperature block)
- Open until a programmable position is reached
- Close when a selectable wind speed is reached (wind alarm, function may be deactivated)
- Close in case of rain (rain alarm, function may be deactivated)

The window is closed in automatic mode as soon as the value of a set indoor temperature falls below or in case of rain/wind alarm.



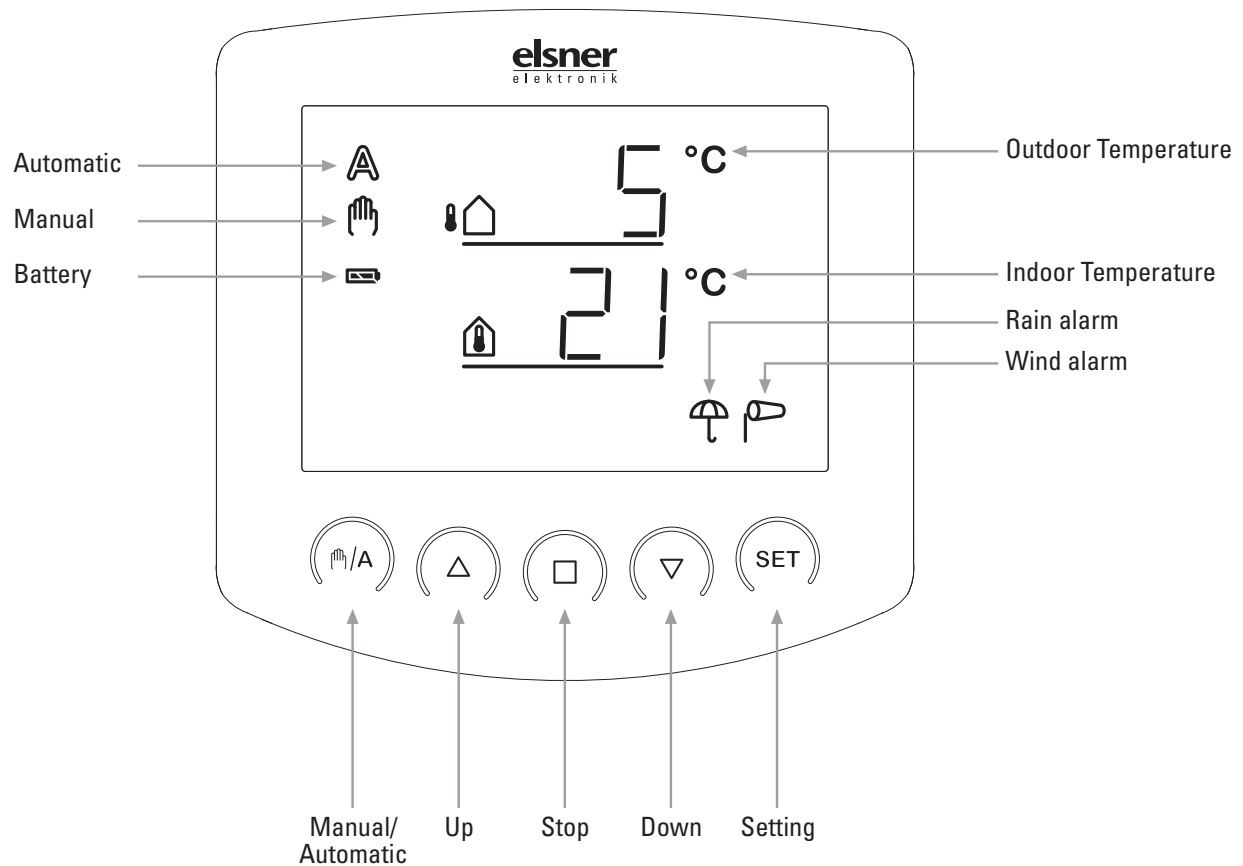

The wind and rain protection functions are also active in manual mode if they have been set in automatic.

Operation

Key functions and display symbols of the meteorological data display



The basic position of the operating unit of the control system displays the current outdoor temperature (upper line) and the indoor temperature (lower line) as well as the function mode (automatic or manual), the battery load and the current alarm messages for rain or wind. The meteorological data are updated once per minute (and in case of a keystroke).

-  Outdoor temperature
-  Indoor temperature
-  Battery symbol (indicates the charge status of the battery) - full
- half full
- empty
-  Automatic mode activated



Manual mode activated. The connected drive mechanism was operated manually (with arrow keys) or /A key was pressed. Thus, the automatic functions are deactivated, there is no control in terms of temperature. The safety functions rain alarm and wind alarm are still activated. The control is in manual mode until you change to automatic mode with /A key.



Rain alarm. The window is closed, manual operation is blocked. The rain protection function may be turned on and off in the automatic settings.



Wind alarm. The window is closed, manual operation is blocked. The wind protection function may be set up or turned off in the automatic settings.

Display of lightness and wind speed

Press the SET key during temperature display once for a short moment, and current lightness (in kilolux, kLux) and wind speed (in meters per second, m/sec) are displayed. The values are updated every 4 seconds.

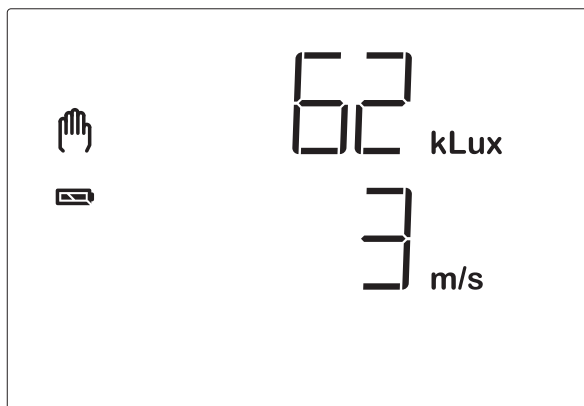

Note: During the first approx. 90 seconds after the return of voltage at the weather station, the wind value is not displayed correctly (e.g. after a power fail or in case of a first start). Therefore, manual operation is blocked in this period of time in case of activated wind alarm.

If you press the SET key again for a short moment, you get back to the temperature display (or to the central command display, see next chapter). After approx. 60 seconds, the display switches automatically to the temperature display.

Manual operation

Manual control as well as the presetting of the automatic functions and the basic setting of the connected shading is accomplished with the keys of the operating unit.

Move window manually



Up



Stop



Down

The connected window may be manually operated with the keys Δ , \square and ∇ . The arrow keys are provided with a time automatic. By short pressing (less than 1 second), the window may be exactly positioned. If the key is pressed more than 1 second, the drive mechanism moves automatically to the final position. If you press \square , the drive mechanism stops.

In case of rain or wind alarm, the manual operation is blocked.

Switch between manual and automatic



Manual/automatic

Key M/A switches between automatic mode (display **A**) and manual mode (display M). After the manual operation with the keys Δ , \square or ∇ , the control system is in manual mode. The automatic functions then are deactivated, there is no control in terms of temperature. With key M/A , the control is reset to automatic (display **A**).

If the next automatic command is an opening command, then the control closes the window at first (4-minute reference movement). After that the opening position is initiated.

Central control

If the sending of meteorological data and automatic commands has been activated (see chapter 5 of the basic settings), you additionally obtain the following display after the manual mode:



In order to get to the display, press key /A twice shortly in automatic mode (A) and once shortly in manual mode ().

As long as the display shows CEN, manual operating commands of this operating unit are submitted to all drive mechanisms in system XS. During this display, use the keys Δ , \square and ∇ in order to centrally operate all drive mechanisms.

Settings (default setting, automatic)



With the **SET** key and by pressing shortly, you access the display of lightness and wind speed.

By pressing long, you access the setting menu of the automatic and the basic setting. For this purpose, please read chapters “Setting of automatic” or „Basic settings“.

Installation and Commissioning

Installation

See installation instructions.

Details for the installation of the weather station

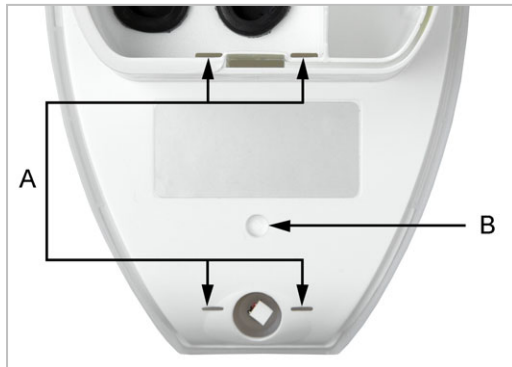

(A) There are drainage openings on the bottom of the housing.

(B) If necessary, the additional, prepared drainage point can be pierced. Proceed with caution so as not to damage the internal circuit board.

Commissioning

ATTENTION!

If a device is brought from a cold to a warm area, condensation can form. Before starting the device up, please ensure there is no moisture inside it (if necessary leave to dry).



After the system has been wired and the connections have been checked, please proceed as follows:

- Switch on the power supply voltage of the weather station.
- Insert batteries in the operating unit as described in chapter “Insert batteries”.
- The display of the operating unit now indicates that the radio connection between weather station and operating unit is not taught in.

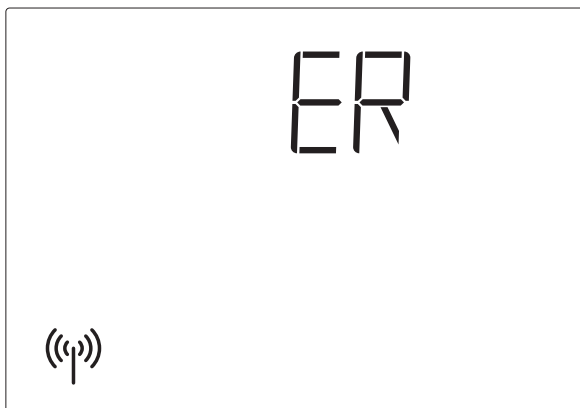

- Press SET key for 3 seconds until the following display appears:

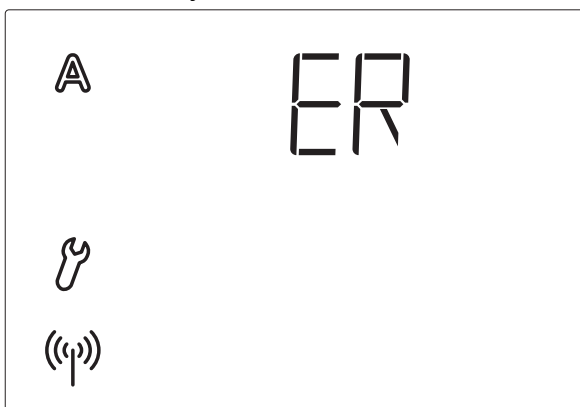

- Press SET again for 3 seconds until the display for the teaching in of the radio connection appears.

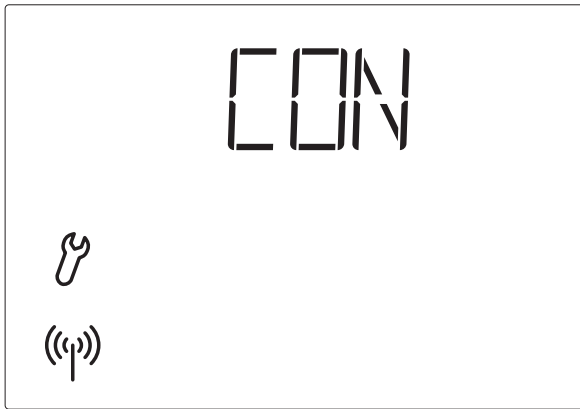

Now you are in basic settings. Proceed as described in the basic settings chapter „1. Radio connection to weather station“ (p. 16).

- Then check the function of the sensors (see next chapter).

Sensor testing

In case of malfunctions of the sensors, the display shows error messages instead of values. Please observe the chapter „Error messages“ on this.

Sun sensor testing

By the short pressing of the SET key on the operating unit you get to the lightness display (see chapter "Display of lightness and wind speed"). The upper value indicates the intensity of lightness in kilolux (kLux).

The sun sensor is located beneath the frosted glass cover of the weather station. If lightness is not sufficient, you must illuminate the weather station from above with a powerful torch until a value is indicated.

Wind sensor testing

By the short pressing of the SET key on the operating unit you access the wind speed display (see chapter "Display of lightness and wind speed"). The lower value indicates the speed in meters per second (m/sec). The sensor pipe is on the front side at the bottom part of the weather station. If you blow in there, the value in the display changes.



Note: During the first approx. 90 seconds after the return of voltage at the weather station, the wind value is not displayed correctly (e.g. after a power fail or in case of a first start).

Rain sensor testing

Humidify one or several of the golden sensor areas in the cover of the weather station.

The  symbol (rain alarm) appears in the display. For this purpose, the rain alarm in the automatic settings must be activated (this is the presetting as delivered, also see chapter "G. Rain alarm"). Please observe that the rain message is maintained for 5 minutes after the drying of the sensor.

Temperature sensor testing

If reasonable values are displayed next to the symbols  (outdoor temperature) and  (indoor temperature), a correct function may be assumed.

Basic settings

These are the basic settings of the device for the commissioning of the control system. The following settings are queried one after the other:

1. Radio connection to the weather station
2. Rotational direction of the motor
3. Operating direction
4. Operating command in case of wind or rain alarm
5. Sending of meteorological and automatic data
6. Opening position
7. Save

This is how you access the basic settings:



In meteorological data display, press the SET key for at least 3 seconds in order to access the automatic setting.

You are in the automatic settings as soon as the symbols **A** and  are indicated left in the display.



Then press again SET for at least 3 seconds in order to access the basic settings.

You are in the basic settings as soon as the symbol  is indicated left in the display and as soon as you can see the first setting step (radio connection).

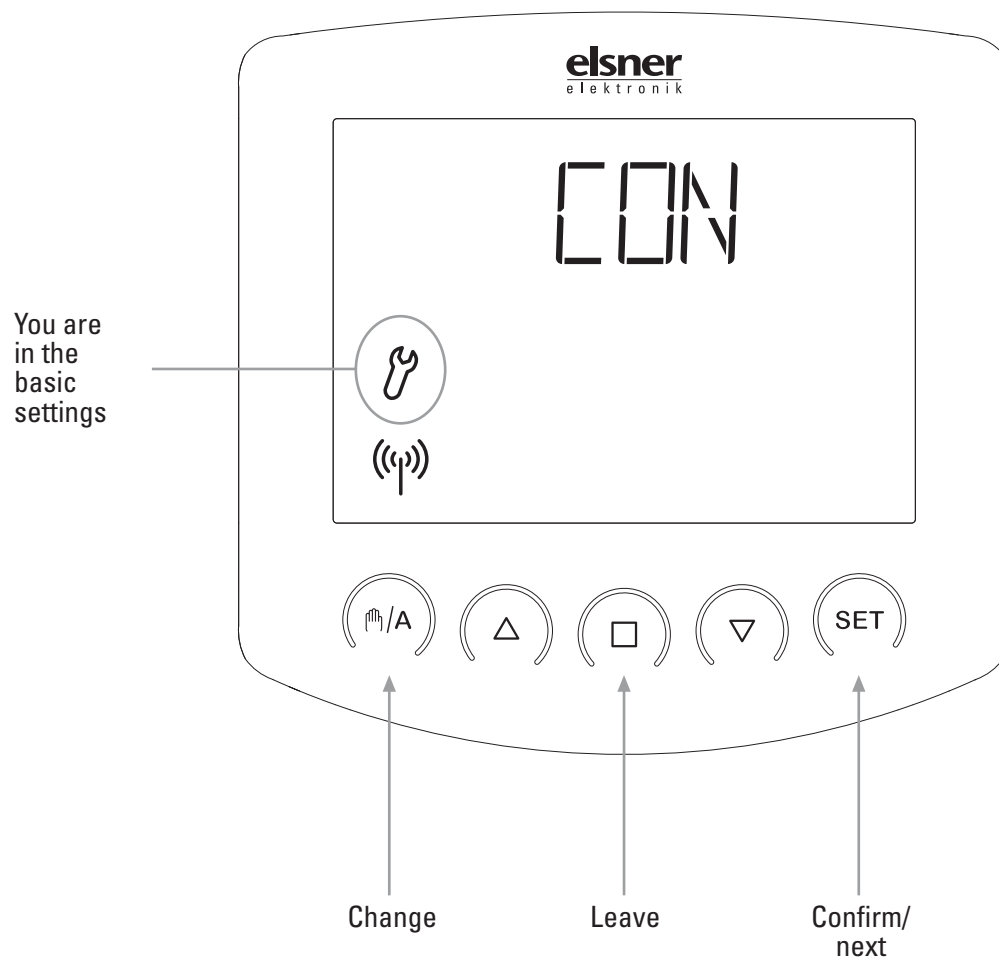

You may leave the basic settings at any time by pressing the key . The accomplished changes are not saved in this case.

If you do not press any key in the basic settings for 5 minutes, the display automatically changes to temperature display. Accomplished settings are not saved either.

1. Radio connection to the weather station

The first step is the teaching in (or later the deletion) of the radio connection.



Select the desired step with the /▲ key:

CON (continue) in order to skip this step,

LEA (learn) in order to teach in a radio connection to the weather station,

CLR (clear) in order to delete an existing radio connection.

Confirm your selection with the SET key.

As soon as you have confirmed LEA (learn) with the SET key, the radio symbol stops flashing and the radio waves are animated (they “run”). Now there are two possibilities:

1. Interrupt voltage supply¹:

Briefly interrupt the voltage supply of the weather station by switching off and on the fuse. The radio connection is learned immediately after switching on again.

2. Programming key of the weather station:

This option of the teaching in may only be accomplished by a qualified person for electronics.



Press the programming key inside the weather station in order to teach in the radio connection (you can find a diagram of the circuit board in the chapter “Preparation of the weather station”).

The learning has been successful if the LED next to the programming key shortly flashes twice and the display skips to step 2 of the basic settings (rotational direction of the motor).

As soon as you have confirmed CLR (clear) with the SET key, the radio connection is deleted. The display automatically skips to LEA (learn) in order to enable the teaching in of a new connection.

¹ from version 4.0 of weather station. Query of software version see “Query service data”, p. 34.

Delete all radio connections of the weather station

You can delete all radio connections of the weather station with operating units and hand-held transmitters at once by pressing the programming key for longer than 5 seconds. The programming LED will go on for 1 second for affirmation. Connections to motor control units are not deleted during this procedure.

2. Rotational direction of the motor

After the teaching in of the radio, you may now set the rotational direction of the motor.

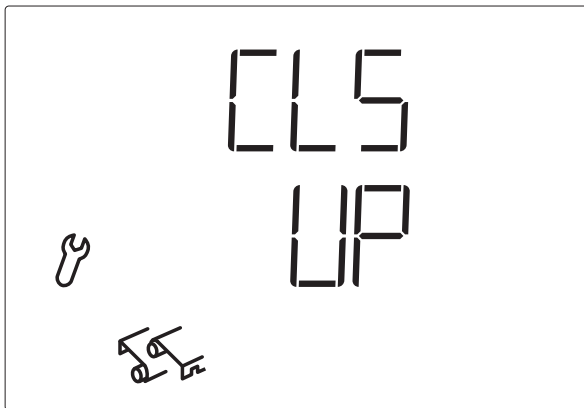

If the up and down connection cables have been mixed up when connecting the drive mechanism, this may be corrected in this step. First open the window a little bit for the rotational direction test. Check both arrow keys and make a setting in the display, whether the window closes again with ∇ or with Δ .

If the window closes (CLS,close) with key Δ , then select the display UP (up) with the key m/A .

If the window closes (CLS, close) with key ∇ , then select the display $\text{d}\square$ (down) with the key m/A .

Press the SET key in order to access the next setting step.

ATTENTION!
Rain and wind alarm are deactivated for this test.



3. Operating direction

After the setting of the rotational direction of the motor, now select which key shall open the window.

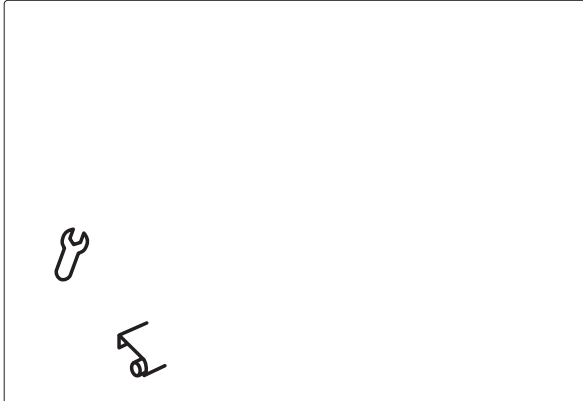

In this step, you change the allocation of the arrow keys so that they correspond with the operating direction of the window. You may directly test the setting with the arrow keys.

Press the key m/\blacktriangle in order to switch between the displayed symbols. Select



if the window shall open with the key \blacktriangle or

if the window shall open with the key \blacktriangledown .

Press the SET key in order to access the next setting step.

ATTENTION!
Rain and wind alarm are deactivated for this test.



4. Operating command in case of wind or rain alarm

After the setting of the operating direction, you may now select whether the operating command in case of wind or rain alarm is temporary or permanent.



After the wind or rain alarm has been activated, the window is closed. The operating command for the connected drive mechanism either ends after 4 minutes or is permanently maintained as long as the alarm message exists. The permanent operating command is necessary if Arexa is used as control centre for wired motor drive units (e. g. IMMSG 230) which control several drive mechanisms.

Press the key /▲ in order to switch between the displays Off and On.

Select

OFF if in case of alarm, the operating command shall stop after 4 minutes (setting for conventional window control systems) or

ON if in case of alarm, the operating command shall be permanently activated (operating command ends as soon there is no alarm message anymore).

Press the SET key in order to access the next setting step.

5. Sending of meteorological and automatic data

After the setting of the operating command in case of wind or rain alarm, you may now select, whether the meteorological data and the automatic commands of Arexa shall be submitted by radio to the motor control units of system XS.

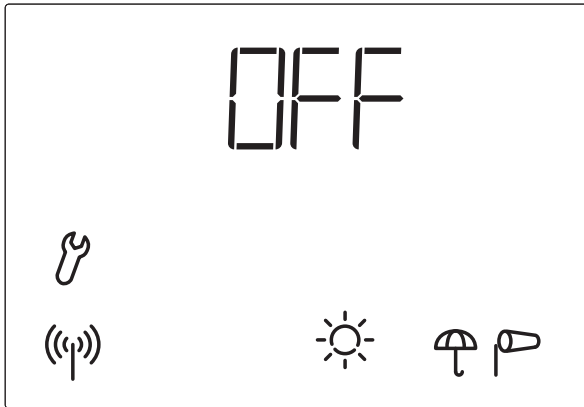

Leave this display at OFF if Arexa is used as conventional single-channel control system. The function „Sending of weather and automatic data“ must only be activated if Arexa shall cooperate with motor control devices (e.g. XS MSG2-AP) in the control system XS.

Press the key /▲ in order to switch between the displays Off and On.

Select

OFF if no meteorological data and automatic commands shall be sent (setting for conventional window control) or

ON if the meteorological data and the automatic commands of the Arexa shall be sent to motor control devices of system XS (setting for the use in the control system XS).

This setting offers the option to centrally operate all drive mechanisms in system XS from the Arexa operating unit (see chapter “Manual operation”).

Press the SET key in order to access the next setting step.

6. Opening position

After the setting of the sending of meteorological and automatic data, you may now teach in an opening position.



You may determine an individual position for the window up to which it opens in automatic mode.

Select the desired step with the F_1/A key:

CON

(continue) in order to skip the setting of the opening position. The window is then always completely opened by the automatic. In this case, continue as described in chapter „7. Saving basic settings“.

LEA

(learn) in order to teach in the opening position.

CLR

(clear) in order to delete an already taught in opening position. The window is then again always completely opened by the automatic. In this case, continue as described in chapter „7. Saving basic settings“.

Confirm your selection with the SET key.

Note: If the control is switched from manual to automatic mode and the next automatic command is an opening command, then the control closes the window at first (4-minute reference movement). After that the opening position is initiated.

6.1. Closed position

After having confirmed `LEA` (learn), the command `CLS` (close) appears.

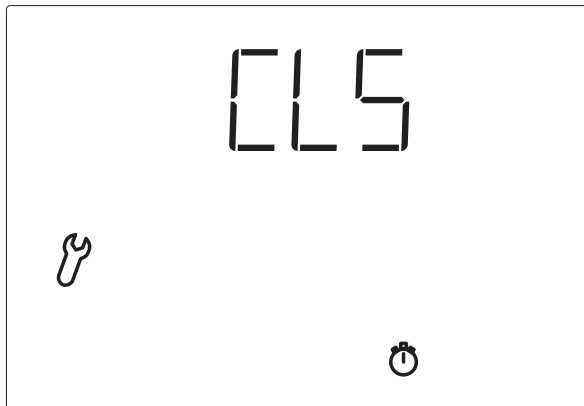

At first, completely close the window. Then press the `SET` key in order to access the next setting step.

6.2. Setting of the desired position

The command `OPN` (open) appears.



Now open the window as far as the automatic shall do it later. Then press the `SET` key in order to access the next setting step.

7. Saving of basic settings

At the end of basic settings, the symbol  (save) asks whether the accomplished setting shall be saved.



Press the SET key in order to save your entered data and to access the meteorological data display. With , you quit the basic settings without saving.

After the basic setting, the values for the automatic functions may be set. In case of first commissioning, please check the function of the sensors in advance (see chapter "Sensor testing").

Setting of automatic

For an optimal aeration, the values for automatic operation must be adjusted to the local conditions. The following settings are queried one after the other:

- A. Indoor temperature for opening
- B. Outdoor temperature block
- C. Wind alarm
- D. Rain alarm
- E. Storage

This is how you access the automatic settings:



In meteorological data display, press the SET key for at least 3 seconds in order to access the automatic setting.

You are in the automatic settings as soon as the symbols **A** and  are shown left in the display. You can see the first parameter (lightness) which must be set.

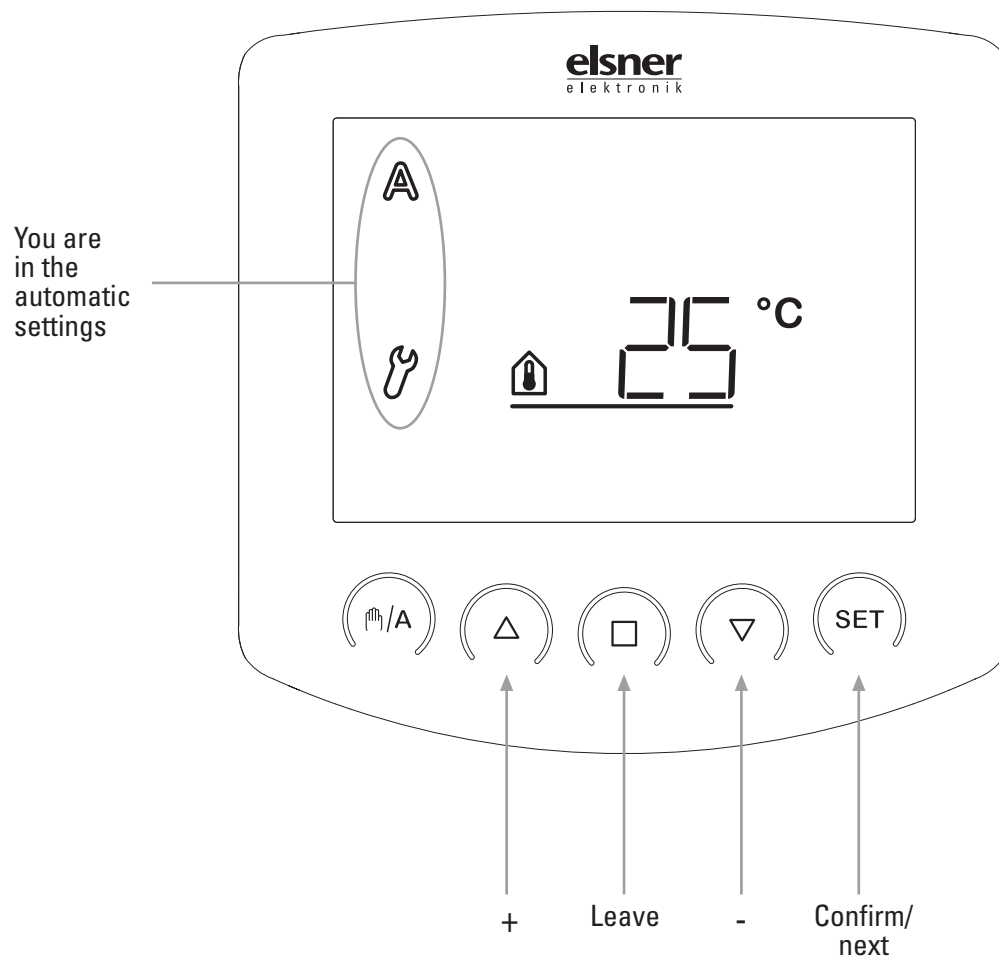

You may leave the automatic settings at any time by pressing the key □. The accomplished changes of the values are not saved in this case.

If you do not press any key in the automatic settings for 5 minutes, the display automatically changes to temperature display. Accomplished settings are not saved either.

Safety instructions for automatic and alarm functions

WARNING!

Risk of injury due to automatically moved components!



The automatic control may cause parts of the system to travel and pose a danger to humans.

- No persons may remain in the travelling range of parts driven by an electric motor.
- Adhere to the relevant building regulations (see guideline for power-operated windows, doors and gates BGR 232 et al).
- Always disconnect the system from the mains power before maintenance or cleaning (e.g. switch off/remove fuse).

In case of power failure, drives and devices can no longer be controlled! If the complete scope of functions must be guaranteed in case of power fail, an emergency power generator with an according switch-over from mains operation to emergency operation must be installed.

Saved settings in the programme of the control also retain in case of power fail. After the return of voltage, the control is in automatic mode.

If the radio connection between operating unit and weather station is interrupted (e.g. by radio interference or empty batteries in the operation unit), it is not possible anymore to take manual action. The control remains in the current mode (manual or automatic). The automatic mode continues as preset until there is radio connection again, however without considering the indoor temperature. In case of a preset manual mode, the wind and rain protection functions are retained as well.

If cleaning or maintenance work is to be carried out on the building, the system must be switched to neutral by switching off the installed fuse and be prevented from unintentional restart. Thus you ensure that the connected drive mechanisms do not start operation.

In case of beginning rain, a certain period of time, which depends on the amount of rain, may pass by until the weather station recognises that there is rain.

In addition, a closing time must be taken into account for electrically operated windows or sliding roofs. Any items that are sensitive to moisture should therefore not be placed in areas where they might be damaged by penetrating moisture.

Please also consider that for example in case of power failure and incipient rain the windows are no longer automatically closed if no emergency power generator has been fitted.

A. Indoor temperature for opening

In the automatic settings, you must indicate at first the lightness from which shading shall start.

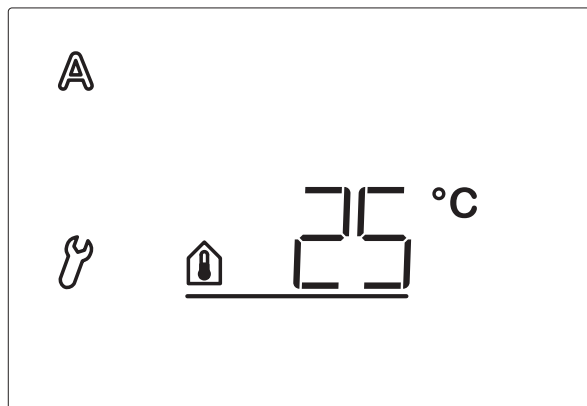

As soon as the value indicated here is exceeded, the automatic opens the window (unless the blocking value for the outdoor temperature has fallen below, see next parameter). The hysteresis is 2°C. That means, that the window will be closed as soon as the indoor temperature drops 2°C below the set value.

The presetting is 25°C.

Adjust the value with Δ (higher) and ∇ (lower) or select OFF (off) in order to switch off the function. You reach the setting OFF by pressing ∇ once more when the display shows "5°C". If you select OFF, there is no control in terms of temperature. Therefore, the following automatic parameter (chapter B) is skipped. The window may be operated manually and the protection against wind and rain is active (if set accordingly, see chapter "C. Wind alarm" and "D. Rain alarm").

Press SET in order to get to the setting of the next parameter.

B. Outdoor temperature block

After the setting of the indoor temperature, now select the maximum outdoor temperature up to which the window shall remain closed.

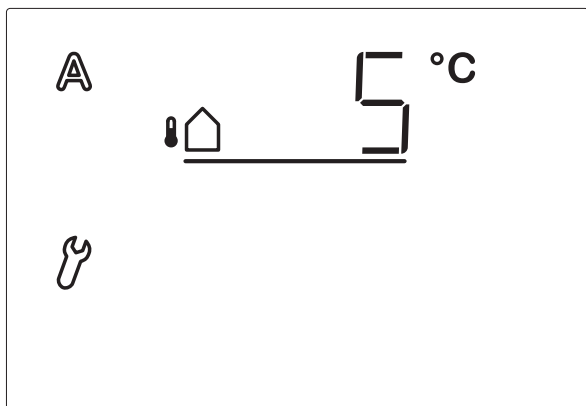

The outdoor temperature block keeps the window closed as long as the temperature is below the selected value. This means that in automatic mode, an opened window is closed and not opened again if the indoor temperature value (chapter A) is exceeded. Thus avoids energy losses during ventilation and protects plants from cold external air.

ATTENTION!

The outdoor temperature block should be set to a temperature *above* 0°C, if possible. If a window is opened while temperatures are *below* 0°C, frozen rubber seals can get damaged.



The hysteresis of the outdoor temperature block is 2°C. That means, the window ventilation is released only after the outdoor temperature has extended the set value more than 2°C.

The presetting for the outdoor temperature block is 5°C.

Adjust the value with Δ (higher) and ∇ (lower) or select OFF (off) in order to switch off the outdoor temperature block. You reach the setting OFF by pressing ∇ once more when the display shows “-20°C”.

Press SET in order to access the setting of the next parameter.

C. Wind alarm

After the setting of the outdoor temperature block, now provide the value for the wind protection function.

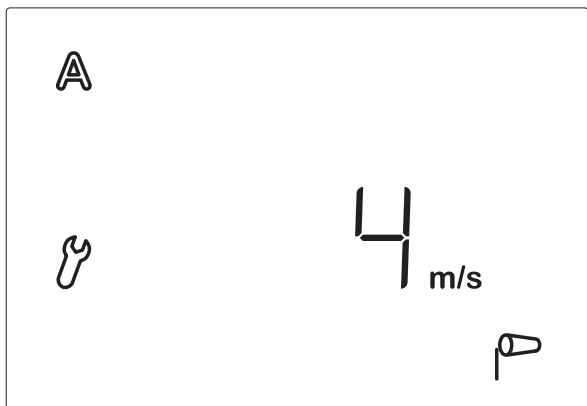

The wind alarm protects the window and furniture and fixtures from damage. If the indicated wind value is exceeded, the window closes and the manual operation is blocked.

Wind speed is indicated in m/sec (meters per second). The wind alarm is maintained for 5 minutes. If the set wind value is exceeded within these 5 minutes, the stop time starts from the beginning.

The following table (see next chapter) serves as indication in order to set the wind value. Depending on the position of the winter garden and the assembly position of the weather station, different wind values may be optimal. Observe the behaviour of the window in case of wind and correct the wind value accordingly.

The presetting for the retraction in case of wind is 4 m/sec.

Adjust the value with Δ (higher) and ∇ (lower) or select OFF (off) in order to deactivate the function.

Then press SET in order to access the setting of the next parameter.

Table for wind speeds

Description	m/sec	km/h	Beaufort	knots
Calm	< 0,3	< 1,1	0	< 1
Almost calm	0,3-1,5	1,1-5,4	1	1-3
Very weak wind	1,6-3,3	5,5-11,9	2	4-6
Weak wind	3,4-5,4	12,0-19,4	3	7-10
Moderate wind	5,5-7,9	19,5-28,4	4	11-16
Fresh wind	8,0-10,7	28,5-38,5	5	17-21
Very fresh wind	10,8-13,8	38,6-49,7	6	22-27
Strong wind	13,9-17,1	49,8-61,5	7	28-33

Very strong wind	17,2-20,7	61,6-74,5	8	34-40
Storm	20,8-24,4	74,6-87,8	9	41-47
Heavy storm	24,5-28,4	87,9-102,2	10	48-55
Gale-force wind	28,5-32,6	102,3-117,3	11	56-63
Hurricane	> 32,6	> 117,3	12	> 63

D. Rain alarm

After the setting of the wind alarm, now select whether the rain alarm shall be switched on or off.

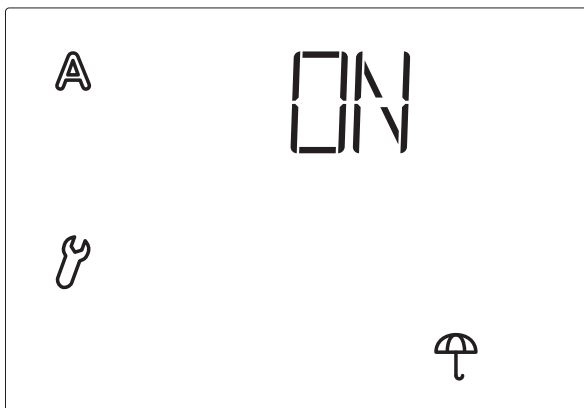

The rain alarm protects furniture and fixtures from damage. In case of rain, the window is automatically retracted and the manual operation is blocked.

The rain message is maintained for 5 minutes. If the system recognises rain again during these 5 minutes, the stop time starts from the beginning.

In the presetting, the rain alarm is activated (display $\square\text{ON}$). With the arrow keys, you may select between activated (display $\square\text{ON}$) and deactivated (display $\square\text{OFF}$). Then press SET in order to get to the storage of the setting.

E. Storage of automatic settings

At the end of the entry of automatic settings, the symbol  (save) asks whether the accomplished setting shall be saved.



Press the SET key in order to save your entered data and to access the meteorological data display. With , you quit the automatic settings without saving.

Service

Service and maintenance

Power outage

In case of power fail, the entered data will be stored for approx. 10 years. Batteries are not necessary for this purpose.

Insert batteries (operating unit)

The battery compartment is inside the housing.

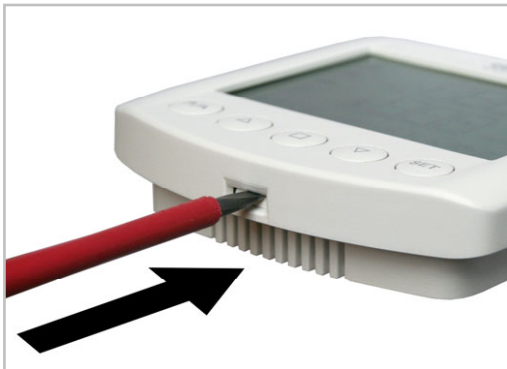

Open the operating unit by unlocking the locking at the lower rim of the housing. For this purpose, you must press with a screwdriver straight into the gap.

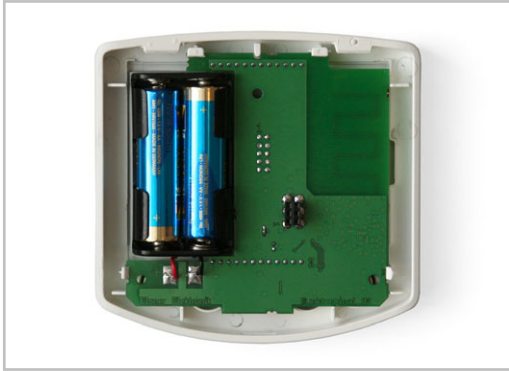

Observe the correct polarity of the batteries. You need two standard batteries (1.5 V) or accumulators (1.2 V) of type AA (Mignon/ LR6).

Close the housing by fitting the front panel with circuit board from above into the rear panel. The locking must engage with a clearly noticeable "click".

Error messages

Despite the values for temperature, lightness or wind speed, the display may indicate error messages in the meteorological data display.

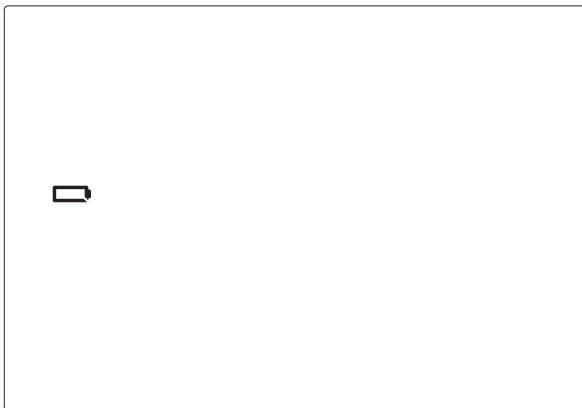

Error:

Battery is displayed, no other symbols or values. Manual operation is possible.

Cause: Batteries in the operating unit are

empty and must be changed. Attention: The function of the operating unit may not be guaranteed anymore.

Action: Change batteries as described in chapter "Insert batteries".



Error:

ER and the symbol for radio appear in the display.

Cause: No radio connection between operating unit and weather station. The weather station is out of order (e.g. has no voltage) or the radio connection is interrupted or has not yet been taught in.

Action:

The error may only be corrected by a qualified person for electronics. Therefore, please contact your fitter.



The teaching in of the radio connection between weather station and operating unit is described in chapter "1. Radio connection to weather station".

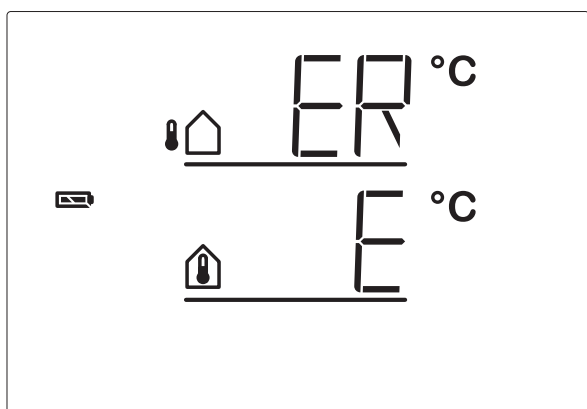

Error:

ER instead of outdoor temperature or
E instead of indoor temperature

Cause: The outdoor temperature sensor of the weather station or the indoor temperature in the operating unit is defect.

Action:

The error may only be corrected by a qualified person for electronics. Therefore, please contact your fitter.

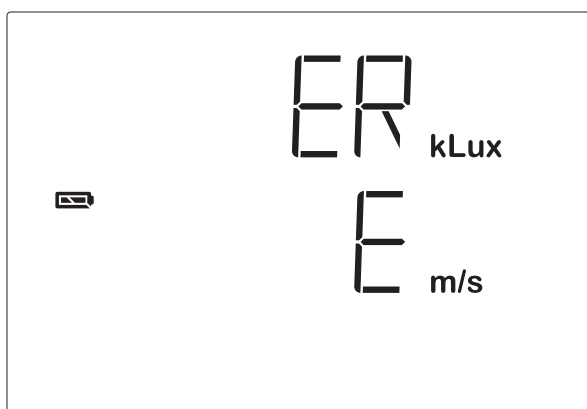

Error:

ER instead of lightness or
E instead of wind speed

Cause: Lightness sensor or wind sensor of the weather station are defect.

Action:

The error may only be corrected by a qualified person for electronics. Therefore, please contact your fitter.



Query service data

The software version of the operating unit and the weather station may be indicated in the display. From the basic settings you may get to the service menu by a long pressing of SET (3 seconds). At first, the software version of the operating unit (PAN, panel) is indicated, after the short pressing of SET, the software version of the control/weather station (PR, Arexa) is indicated. Display 10 means version 1.0, 12 means 1.2, etc. Quit the service data display by another short pressing of SET.

Disposal

End users are statutorily required by s. 18 Battery Act to return old batteries. After use, the batteries can be returned to Elsner Elektronik free of charge or they can be recycled via a public-law waste management provider.

Factory settings

The following presetting for the automatic is stored when the Arexa control system is delivered:

- Opening from indoor temperature > 25°C
- Blocking until outdoor temperature > 5°C
- Wind alarm beginning with 4 m/sec
- Rain alarm activated

Connection samples for several drive mechanisms as group

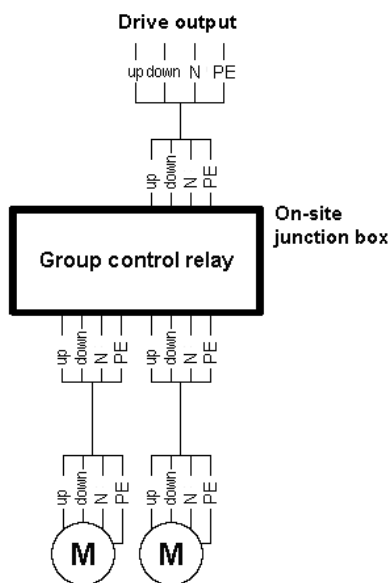

Drive group with a **total output of less than 500 VA** at the drive output of the weather station or at a motor control unit.

Motors without integrated group control relay.

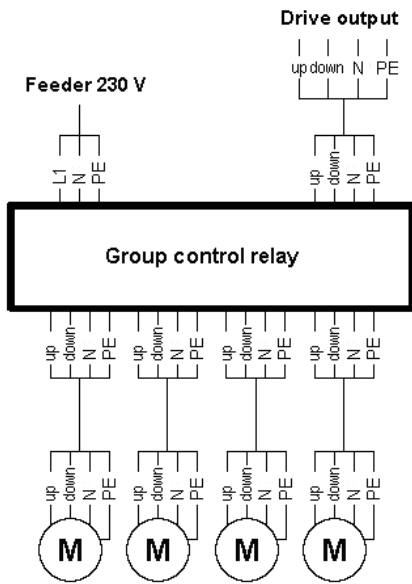

Drive group with a **total output of more than 500 VA** at the drive output of the weather station or at a motor control unit. The possible total output depends on the group control relay.

Motors without integrated group control relay.

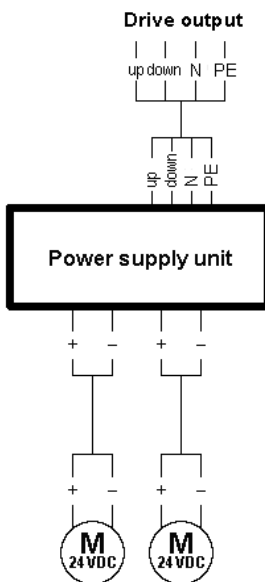

Drive group with **DC motors** at the drive output of the weather station or at a motor control unit.

Connection samples for centralised control with motor control units

Simple central control with motor control units (MCU) at the drive output of Arexa weather station:

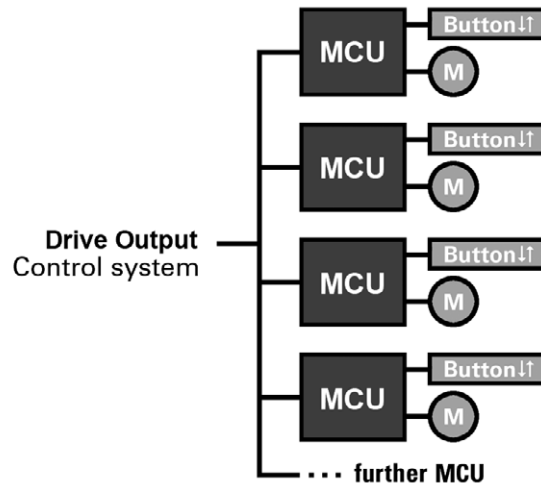

Central control with group formation with motor control units (MCU) at the drive output of Arexa weather station:

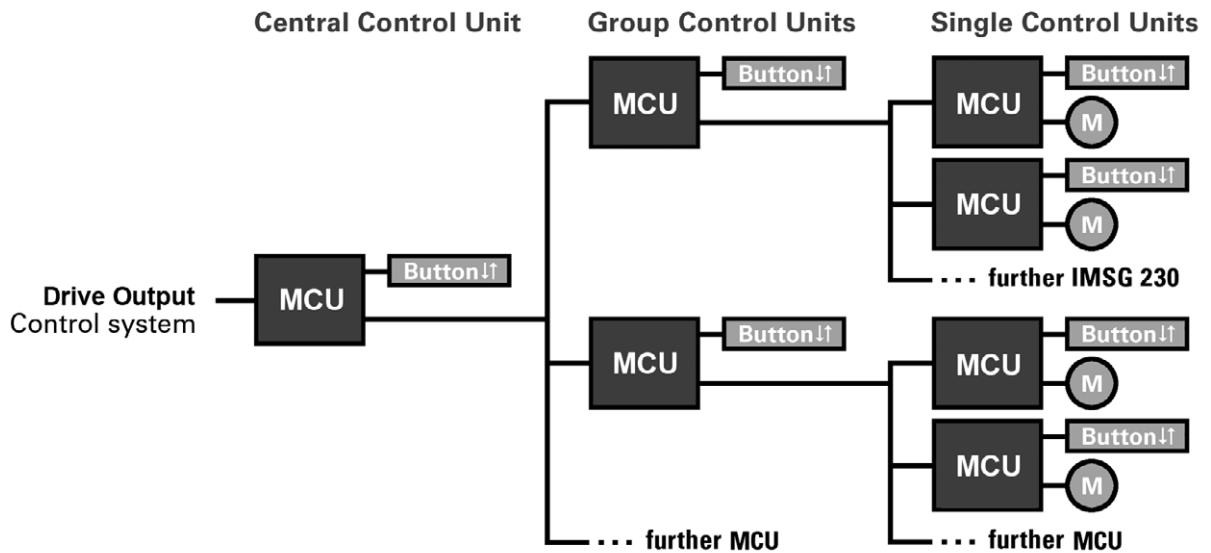

Personal setting data of the automatic

Opening if indoor temperature exceeds		°C
Outdoor temperature block below		°C
Wind alarm from		m/sec
Rain alarm		(Yes/No)

Questions about the product?

You can reach the technical service of Elsner Elektronik under

Tel. +49 (0) 70 33 / 30 945-250 or
service@elsner-elektronik.de

We need the following information to process your service request:

- Type of appliance (model name or item number)
- Description of the problem
- Serial number or software version
- Source of supply (dealer/installer who bought the device from Elsner Elektronik)

elsner

Elsner Elektronik GmbH Control and Automation Technology

Sohlegrund 16
75395 Ostelsheim
Germany

Phone +49(0)7033/30945-0
Fax +49(0)7033/30945-20

info@elsner-elektronik.de
www.elsner-elektronik.de
